



POWER FROM WITHIN

GUIDA TECNICA
**REGOLATORE
DIGITALE DER1**

DER1 DIGITAL REGULATOR

TECHNICAL GUIDE

INDEX	pag. 2
INTRODUCTION	pag. 3
MAIN CHARACTERISTICS	pag. 3
1. Architecture of the system	pag. 3
1.1 Regulator	pag. 3
1.2 Communications module	pag. 3
2. Technical Characteristics	pag. 4
3. Inputs and Outputs: technical specifications	pag. 5
4. Block diagram	pag. 6
INSTALLATION	pag. 7
1. Overall dimensions drawings	pag. 7
2. Connections	pag. 8
3. Terminals	pag. 8
4. DER1 connections	pag. 8
4.1 Connections based on voltage	pag. 8
4.2 DER1 connections for typical applications	pag. 9
5. Setting up the regulator	pag. 9
5.1 Alternator voltage signals	pag. 9
5.2 Calibrating sensing	pag. 9
6. 50/60 Signal	pag. 9
7. APO Contact	pag. 9
8. Remote control of voltage	pag. 16
9. VOLT, STAB,Hz and AMP Trimmers	pag. 17
10. Serial communications	pag. 17
PARAMETERS AND OPERATING DATA	pag. 18
1. ModBus registry list	pag. 18
2. Word of configuration (Parameter P[10])	pag. 18
3. RAM location reference, activation of saturation in analog remote control	pag. 19
4. Volatile memory addresses	pag. 20
5. Fourth Status Word (Location L[39])	pag. 20
SETTING OF VOLT, STAB, AMP and Hz PARAMETERS	pag. 21
1. Voltage	pag. 21
1.1 Setting voltage	pag. 21
1.2 Soft Start	pag. 21
1.3 Slow voltage variations	pag. 22
2. Stability	pag. 22
2.1 Adjustment of stability	pag. 22
3. Excitation overcurrent	pag. 26
3.1 Description	pag. 26
3.2 Calibration with a supervision unit	pag. 27
3.3 Calibration without a supervision unit	pag. 27
4. Underspeed	pag. 27
4.1 Description	pag. 27
4.2 Calibration with a supervision unit	pag. 28
4.3 Calibration without a supervision unit	pag. 28
5. Underspeed	pag. 29
6. Other parameters	pag. 29
6.1 Vout / Vaux Ratio	pag. 29
6.2 V/F slope at start up	pag. 29
6.3 Short circuit time	pag. 29
CONTROLLING OF REGULATOR ALARMS	pag. 30
1. Alarm signals with the indicator lights	pag. 30
2. Description of alarms	pag. 31
3. APO Output	pag. 32
4. Board operation time	pag. 32
APPENDIX	pag. 33

The information contained in this manual may be modified without advance notice.
This revision supersedes and replaces all previous editions.
Even partial reproduction of this manual is prohibited, with any means whatsoever, without prior written authorisation by Mecc Alte S.p.A.

INTRODUCTION

This manual contains information on the operation and use of the DER1 digital regulator.



In order to avoid damage to persons and/or property, only qualified personnel, having full knowledge and understanding of the information contained in this manual, should perform the procedures described herein; when power to the unit is on, the voltage present may be lethal for the operator.



All connections must be made with the power off.

The plastic protections on connectors J1 and J2 must not be removed for any reason whatsoever.

MAIN CHARACTERISTICS

1. Architecture of the system

The DER1 is a voltage regulator for synchronous alternators, designed for stand alone working and calibration; to maximize performances, the regulator should be intended as part of a system made up of at least three components: the DER1 (control unit), a communications module (USB2DxR, for example) and a supervision unit, as illustrated in figure 6.

The connectors for connection to and from the power generator and communications module are located on the DER1 regulator.

The supervision unit can be made up of a personal computer, another “synoptic” device or both; it does not have the function of controlling the system in real time, but allows programming and visualisation of all operational parameters of the DER1.

If it is equipped with USB interface, it's possible to use the USB2DxR communications module for its connection.

1.1 Regulator

Since the regulator is designed to control many different types of generators, it must be appropriately configured to obtain the best performance; most of the settings are stored in a non-volatile integrated memory (EEPROM). The first time the regulator is turned on, a default configuration will be present, which satisfies the most widely requested characteristics and is suitable to facilitate installation: the trimmers are active and the inputs for the external potentiometer and the 60 Hz jumper are enabled, therefore the basic calibrations can be performed without the use of additional equipment.

Two versions of the DER 1 and DER 1/A regulators are available; the first one is optimised for Mecc Alte Series 3 to 38 alternators, while the second is optimised for Mecc Alte series 40, 43 and 46 alternators; the two versions differ primarily in the default parameters.

NOTE: the parameter that defines the output voltage (with the VOLT trimmer disabled) is set on 0 (so that the adjustment takes place on the minimum voltage).

1.2 Communications module

The USB2DxR communications module (which is provided for connection to the COM connector of the DER1) is equipped with a USB port, through which it is possible to set the parameters (for both configuration and operation) and “monitor” operation of the generator.

2. Technical Characteristics of the device installed on board

- Digital controlled regulator, based on DSP
- Suitable for all Mecc Alte self-regulated alternators
- Power connections through 20 poles⁽¹⁾ Fast-On connector (see fig.2)
- Protection of power winding with 5A fast acting fuse
- Signal connections (Pext, 60Hz Jumper, APO) through 10 poles mini Fast-On separate connector
- Environmental temperature: $-25^{\circ}\text{C} \div +70^{\circ}\text{C}$
- Voltage supply: $40\text{Vac} \div 270\text{Vac}$ ⁽²⁾(from auxiliary winding, output voltage or PMG)
- Maximum continuous output current: 5A_{dc}
- Frequency range: $12\text{Hz} \div 72\text{Hz}$
- Three phase or single phase sensing in all connections (Y- Δ -YY- $\Delta\Delta$)
- Single phase or three phase sensing automatic recognition
- Average value of voltage regulation
- Voltage regulation range (sensing) from 75Vac to 300Vac
- Precision of voltage regulation: $\pm 1\%$ from no-load to nominal load in static condition, with any power factor and for frequency variations ranging from -5% to +20% of the nominal value.
- Precision of voltage regulation: $\pm 0,5\%$ in stabilized conditions (load, temperature).
- Transient voltage drop and overvoltage within $\pm 15\%$
- Voltage recovery time within $\pm 3\%$ of the value set, in less than 300 msec.
- Programmable Soft start
- Parameters: VOLT, STAB, AMP and Hz settable by trimmers (default), 50/60Hz settable by a "jumper" (default), all parameters programmable via software
- $0 \div 2,5\text{Vdc}$ or $-10 \div +10\text{Vdc}$ external voltage for analogical remote control of output voltage
- Remote control of output voltage through external potentiometer (from 25Kohm to 100Kohm)
- Underspeed protection with adjustable threshold and slope
- Overvoltage and undervoltage alarms
- Excitation overcurrent protection with delayed intervention
- Underexcitation alarm/loss of excitation⁽⁶⁾
- Management of temporary short circuits (start up of asynchronous motors)
- Open collector output (not insulated) signalling some alarm intervention with programmable activation in respect of each alarm and possibility of the intervention delay and selectable active level⁽⁶⁾
- Alarm conditions storage (type of alarm, number of events, duration of the last event, total time)
- Memorization of the regulator operation time
- USB communications interface (with optional USB2DxR module)

WARNING : Operation of the DER1 is not specified below 12 Hz.

NOTE (2) : with EMI external filter SDR 128/K, see Fig.4 (3m without EMI filter)

NOTE (6) : Starting from rev. 19 of the firmware

3. Inputs and Outputs: technical specifications

TABLE 1 : CONNECTOR CN1				
Terminal ⁽¹⁾	Name	Function	Specification	Notes
1	Exc-	Excitation	Continuous Rating: 5Adc Transitory Rating:12Adc at peak	
2	Aux/Exc+			
3	Aux/Exc+	Power	40÷270 Vac, Frequency: 12÷72Hz ⁽²⁾	(1)
4	UFG	Sensing Range 2	Range 2: 150÷300 Vac Burden: <1VA	U channel
5	UFG			
6	UHG	Sensing Range 1	Range 1: 75÷150 Vac Burden: <1VA	
7	UHG			
8	UHB	Jumper Range1		Short for sensing 75÷150 Vac
9	UFB			
10	UFB			
11	UFB		Board reference	Star point (12 YY or 6 Y leads generators) is hard connected to AVR power supply input ⁽¹⁾
12	UFB			
13	-		Not present	
14	VFG	Sensing	Range 1: 75÷150 Vac Burden: <1VA Scala 2: 150÷300 Vac Burden: <1VA	V channel, to be connected in parallel to U channel in case of single phase sensing
15	VHG	Sensing Range 1		
16	VHB			
17	VFB	Range 2		
18	-		Not present	
19	WFG	Sensing	Range 1: 75÷150 Vac Burden: <1VA Range 2: 150÷300 Vac Burden: <1VA	W channel, unused (with shorted inputs) in case of single phase sensing
20	WHG	Sensing Range 1		
21	WHB			
22	WFB	Range 2		

TABLE 2 : CONNECTOR CN3				
Terminal	Name	Funcion	Specifications	Notes
23	Common	Active protections output	Type: Non-insulated open collector Current: 100mA Voltage: 30V Max length: 30m ⁽³⁾	Programmable : active level ⁽⁶⁾ , activating alarm and delay time
24	A.P.O.			
25	Common	Jumper 50/60Hz	Type: Not insulated Max length: 3m	Selection of underspeed protection threshold ⁽⁴⁾
26	50/60Hz			
27	0EXT	Jumper for remote voltage control 0÷2,5Vdc	Type: Not insulated Max length: 3m	Short for 0÷2,5Vdc input or potentiometer
28	JP1			
29	0EXT	Input for remote voltage control 0÷2,5Vdc or Pext	Type: Not insulated Max length: 30m ⁽³⁾	Regulation: ±10 % ⁽⁵⁾
30	PEXT			
31	JP2	Pext Jumper	Type: Not insulated Max length: 3m	Short for 0÷2,5Vdc input or potentiometer
32	±10V			
		control ±10 Vdc	Input: ±10Vdc	Burden: ±1mA (source/sink)

Note 1) The terminals are connected to each other on the board: 2 with 3, 4 with 5, 6 with 7, 9 with 10, 11 and 12.

Note 2) Minimum power voltage 40 Vac at 15 Hz, 100 V at 50 Hz, 115 V at 60 Hz

Note 3) With external EMI filter 182/K (3m without EMI filter)

Note 4) 50·(100%-αHz%) or 60·(100%-αHz%) where αHz% is the position relative to the Hz trimmer or the percent age value of parameter P[21]

Note 5) Value not to be exceeded. The effective range depends on parameter P[16]

Nota 6) Starting from revision 19 of the firmware

TABELLA 3: TRIMMERS

Name	Function	Notes
VOLT	Voltage Calibration	From 75Vac to 150Vac or from 150Vac to 300Vac, see paragraph "Setting the voltage"
STAB	Calibration of dynamic response	Adjustment of proportional gain, see paragraph on "Stability".
Hz	Calibration of underspeed protection intervention threshold	Variation up to -20% with respect to the nominal speed value set in parameter 50/60.
AMP	Calibration of excitation overcurrent protection	See paragraph "Calibration of excitation overcurrent protection"

4. Block diagram

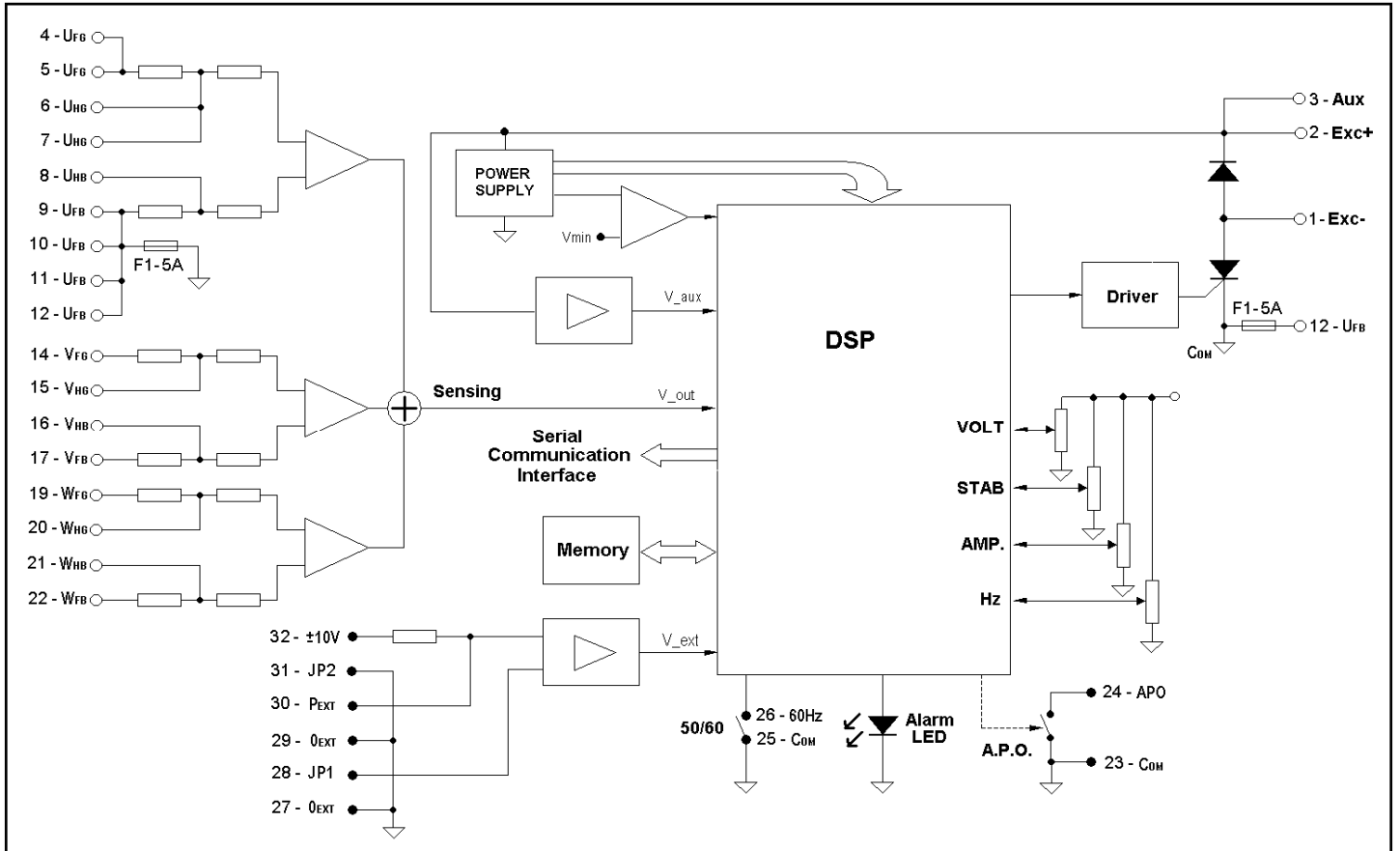

Fig 1

INSTALLATION

Upon receipt of the digital regulator, perform a visual inspection to ensure that no damage has been sustained during transportation and movement of the equipment. In the event of damage, advise the shipper, the insurance company, the seller or Mecc Alte immediately. If the regulator is not installed immediately, store it in its original packaging in a dust and humidity-free environment.

The regulator is normally installed in the generator terminal box. It is fixed with two M4x25 screws and must be installed in a location where the temperature does not exceed the environmental conditions foreseen. The regulator is equipped with a 5A fast-acting protection fuse. If necessary, the fuse must be replaced only with a fuse of the same type and rating.

1. Overall dimensions drawings

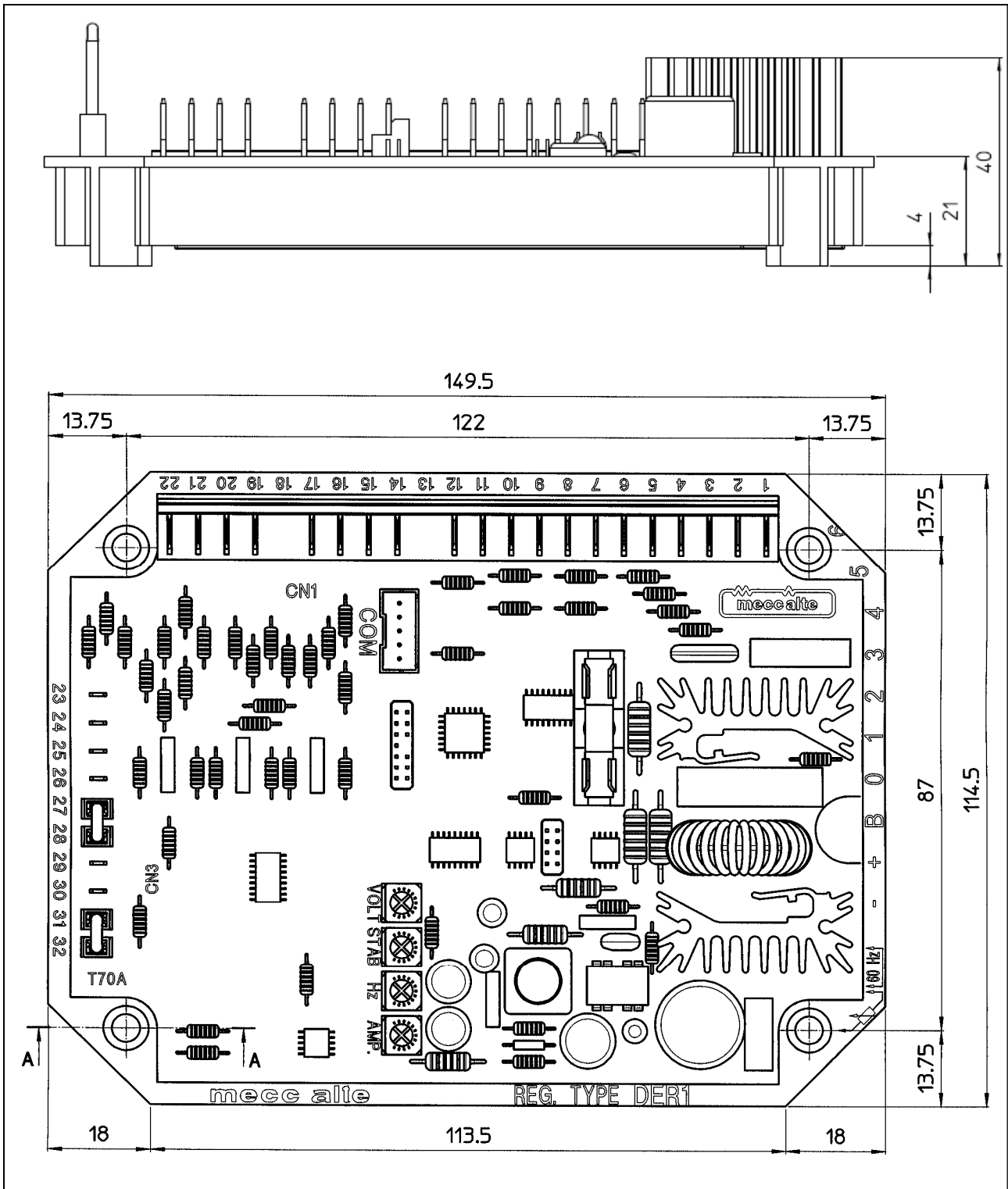

dimensions in mm

Fig 2

2. Connections

The digital regulator connections depend on the application and excitation system. Figure 1 shows the functional aspect of the connection points to the regulator

An error in connection may have deadly consequences for the unit.

Carefully check to make sure that all connections are precise and in accordance with the attached drawings, before turning on the power.

3. Terminals

Figures 1 and 2 show the connection terminals; the connections must be made using cables having a minimum diameter:

- 1,5 mm² for power cables on terminals from 1 to 22
- 0,5 mm² for signal cables on terminals from 23 to 32

4. DER1 connections

The DER1 regulator has 3 differential inputs, with 2 selectable scales for each of them (see fig. 1):

- scale "H" for voltages between 75V and 150V
- scale "F" for voltages between 150V and 300V

4.1 Connections based on main alternator voltage

Based on the machine connections, and the desired voltage⁽¹⁾ you can use the three phase or single phase sensing used in one range or the other. Table 4 summarises the connections for the most common voltages.

TABLE 4: ALTERNATOR VOLTAGE AND SENSING CONNECTION					
Connection	Phase-to-Phase Voltage [V]	Sensing - Phase	Range	Drawing	Notes
Series star	380-400-415-440-460-480-500 (from 260 to 500)	Single phase on half phase	H	SCC0160/03	
		Three phase on half phase	H	SCC0158/05	
		Single phase on full phase	F	N.A.	
		Three phase on full phase	F	N.A.	
	530-550-575-600-690-760-800-920-960(from 520 to 1000)	Single phase on half phase	F	SCC0161/03	
		Three phase on half phase	F	SCC0159/05	
1200 (from 1100 to 2000)	Single phase on half phase	F	SCC0202/01		2 channels in series
Parallel star	190-200-208-220-230-240-250 (from 130 to 250)	Single phase	H	SCC0160/03	
		Three phase	H	SCC0158/05	
	380-400-415-440-460-480-500 (from 260 to 500)	Single phase	F	SCC0161/03	
		Three phase	F	SCC0159/05	
Series delta	220-230-240-254-265-277-290 (from 150 to 300)	Single phase on half phase	H	SCC0160/03	
		Three phase on half phase	H	SCC0158/05	
	305-320-330-440-460-530-555 (from 300 to 600)	Single phase on half phase	F	SCC0161/03	
		Three phase on half phase	F	SCC0159/05	
	220-230-240-254-265-277-290 (from 150 to 300)	Single phase on full phase	F	N.A.	
		Three phase on full phase	F	N.A.	
Parallel delta	110-115-120-127-133-138-145 (from 75 to 150)	Single phase	H	SCC0160/03	
		Three phase	H	SCC0158/05	
	152-160-165-220-230-265-277 (from 150 to 300)	Single phase	F	SCC0161/03	
		Three phase	F	SCC0159/05	
Zig-Zag ⁽²⁾	330-346-360-380-400-415-430 (from 260 to 500)	Single phase on full phase	F	N.A.	
		Three phase on full phase	F	SCC0203/01	2 channels in series
Single phase parallel	220-230-240-254-265-277-290 (from 150 to 300)	Single phase - Partial	H	SCC0160/03	
		Single phase - Complete	F	N.A.	
	305-320-330-440-460-530-555 (from 300 to 600)	Single phase - Partial	F	SCC0161/03	
		Single phase - Complete	F	N.A.	2 channels in series

(1) Compatibly with the rated characteristics of the alternator

(2) Sensing only on full phase

4.2 DER1 connections for typical applications

Drawings SCC158/04, SCC159/04, SCC160/02, SCC161/02 show DER1 regulator connections for typical applications.

In case of sensing 75V-150V, with half-phase reference the typical drawing for three-phase connection is SCC158/04, while for single phase it is SCC160/02.

In case of sensing 150V-300V, with half-phase reference the typical drawing for three-phase connection is SCC159/04, while for single phase it is SCC161/02.

5. Setting up the regulator

Selection of the sensing scale takes place directly according to the connection on the power terminal board; additional settings can be made with 4 trimmers (VOLT, STAB, AMP and Hz) and 3 jumpers (50/60Hz, JP1 and JP2); the output voltage can also be set with an external analogical signal; additional settings, including the previous ones but excluding jumpers JP1 and JP2, can be made by modifying the 25 parameters stored in a non volatile integrated memory.

5.1 Alternator voltage signals

Terminals 4-22 of connector CN1 are used for voltage sensing.

5.2 Calibrating sensing

A supplementary calibration may be necessary to compensate any existing tolerances on analogical voltage acquisition channels; in this case follow the procedure illustrated below.

1. Write **16384** at location 19 (from the **Settings/Advanced**⁽¹⁾ Menu)
2. Disable VOLT trimmer (from the **Settings/Potentiometers**⁽¹⁾ Menu)
3. Disable Vext (from the **Settings/Advanced**⁽¹⁾ Menu)
4. The parameter present in parameter P[5](if three phase sensing) or p[6] (if single phase sensing) has to be calibrated. Calibration should be adjust in order to obtain 225V from the generator output when the sensing is cabled to U_{FB} (9-10-11-12) and U_{FG} (6-7), or to 125.5V if connected U_{FB} (9-10-11-12) and U_{HG} (6-7). Please note that a parameter increment will result in a voltage reduction of the system. It is recommended to measure the voltage output with an instrument capable to catch the average value of the voltage.
5. In order to ensure that the value of voltage (available also at location 36) is the same as the value measured at point 6, calibrate the data at location 7, reading the value of Volt box in the "status" area of **Settings/Advanced**⁽¹⁾ menu.
6. Enable the trimmers again, if it is desired to have them active (from the **Settings/Potentiometers**⁽¹⁾ menu).
7. Enable Vext (from the **Settings/Advanced**⁽¹⁾ Menu) if you want to be active.

6. 50/60 Signal

A jumper is located on the 50/60 input (terminals 25 and 26); if enabled from the **Configuration** Menu, it provokes the commutation of the underspeed protection threshold from $50 \cdot (100\% - \alpha Hz\%)$ to $60 \cdot (100\% - \alpha Hz\%)$, where $\alpha Hz\%$ represents the position relative to the Hz trimmer or the percentage value entered at parameter [21 (where 10% corresponds to 16384).

7. APO Contact

The acronym **APO** stands for **Active Protection Output**: (connector CN1 terminals 23 and 24) 30V-100mA non-insulated open collector transistor, normally closed, if the "APO Invert" flag ⁽²⁾ is active (default), opens (with a delay that can be programmed from 1 to 15 seconds) when, of all the alarms, one or several separately selectable alarms are active.

NOTE ⁽¹⁾: Software DxR Terminal

NOTE ⁽²⁾: Starting from rev. 18 of the firmware, if the "APO Invert" flag is not active or for firmware revisions up to 17 the transistor is normally open and it closes in case of an active alarm

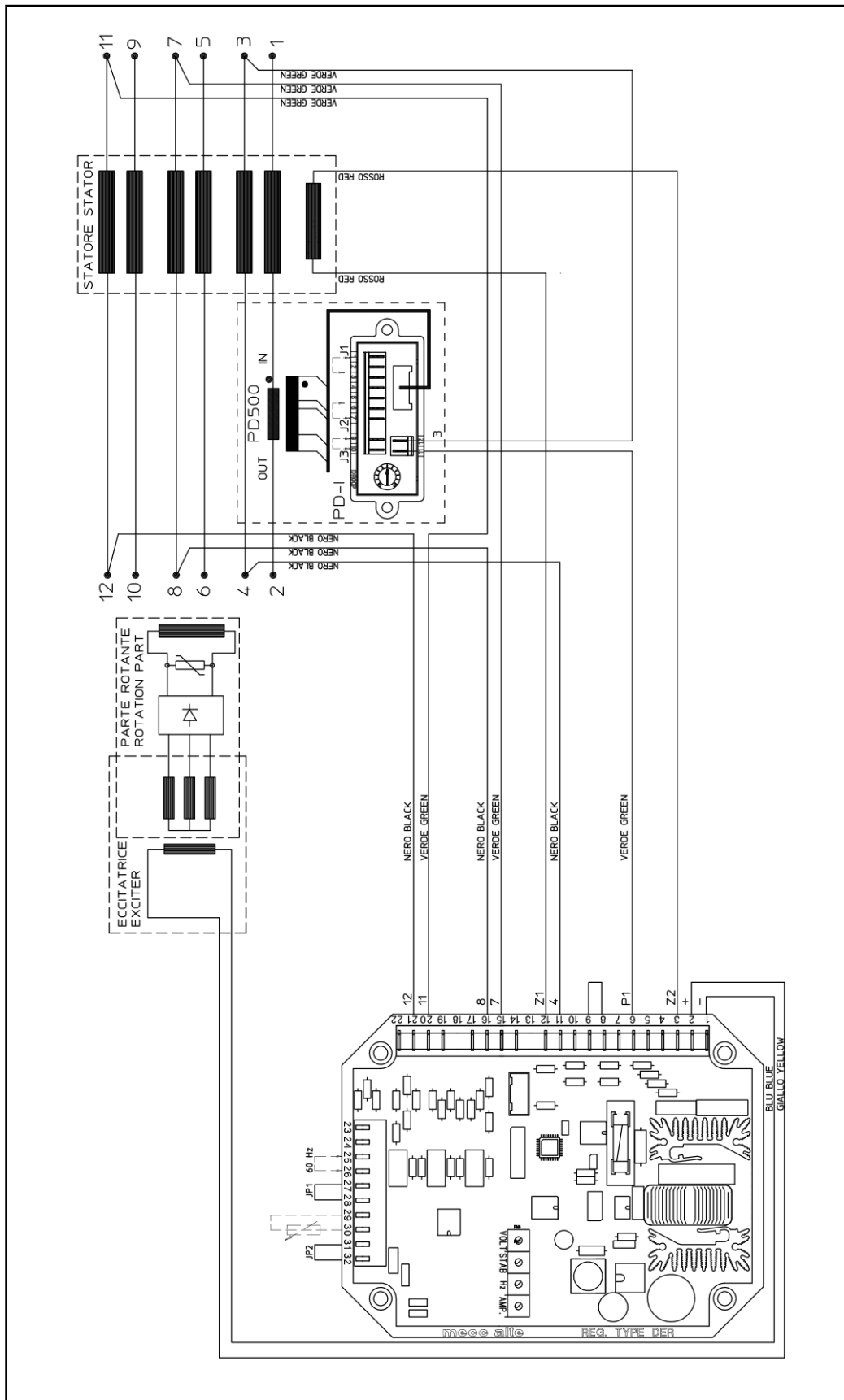

SCC0158/05: Three phase sensing 75V-150V

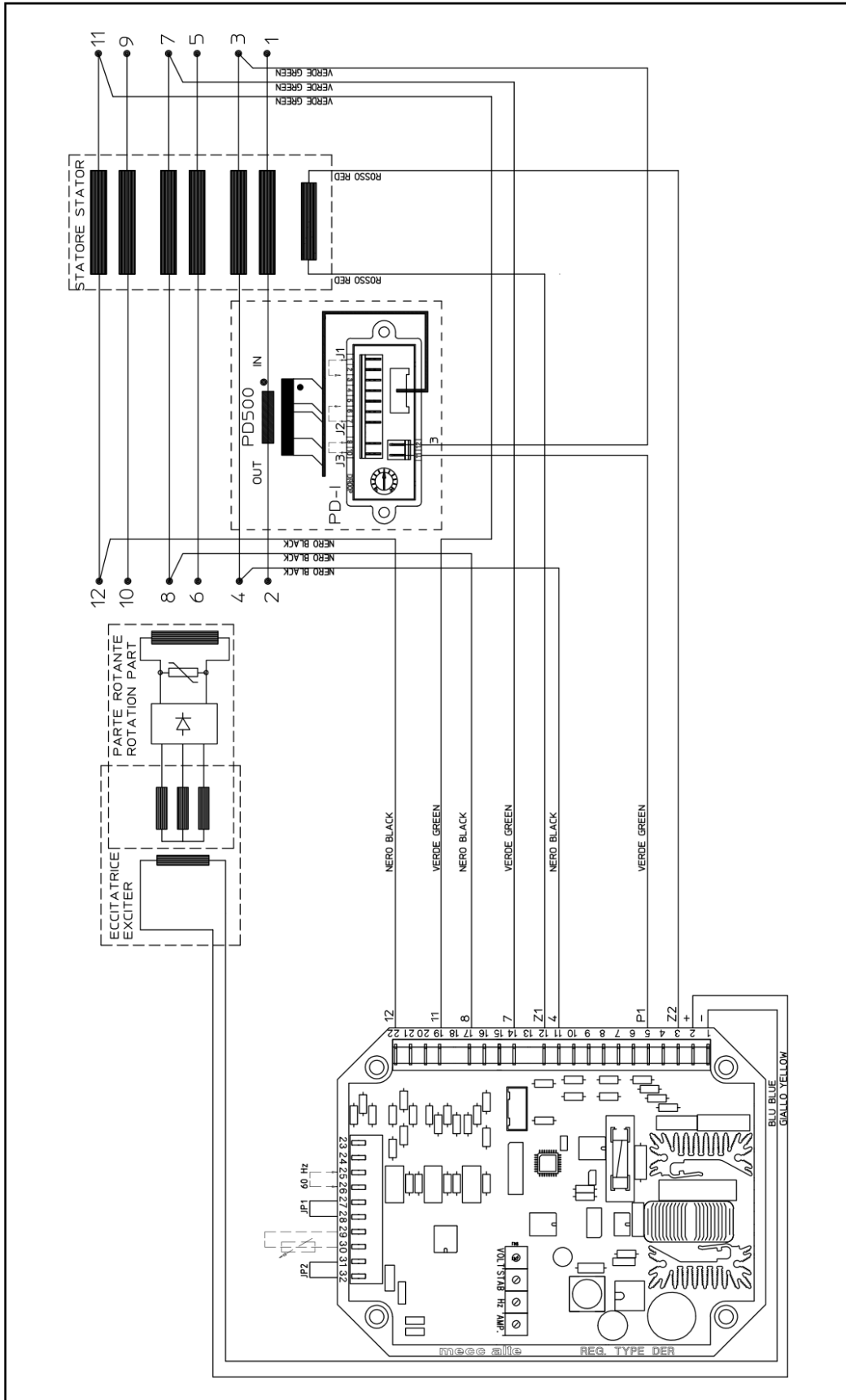

SCC0159/05: Three phase sensing 150V-300V

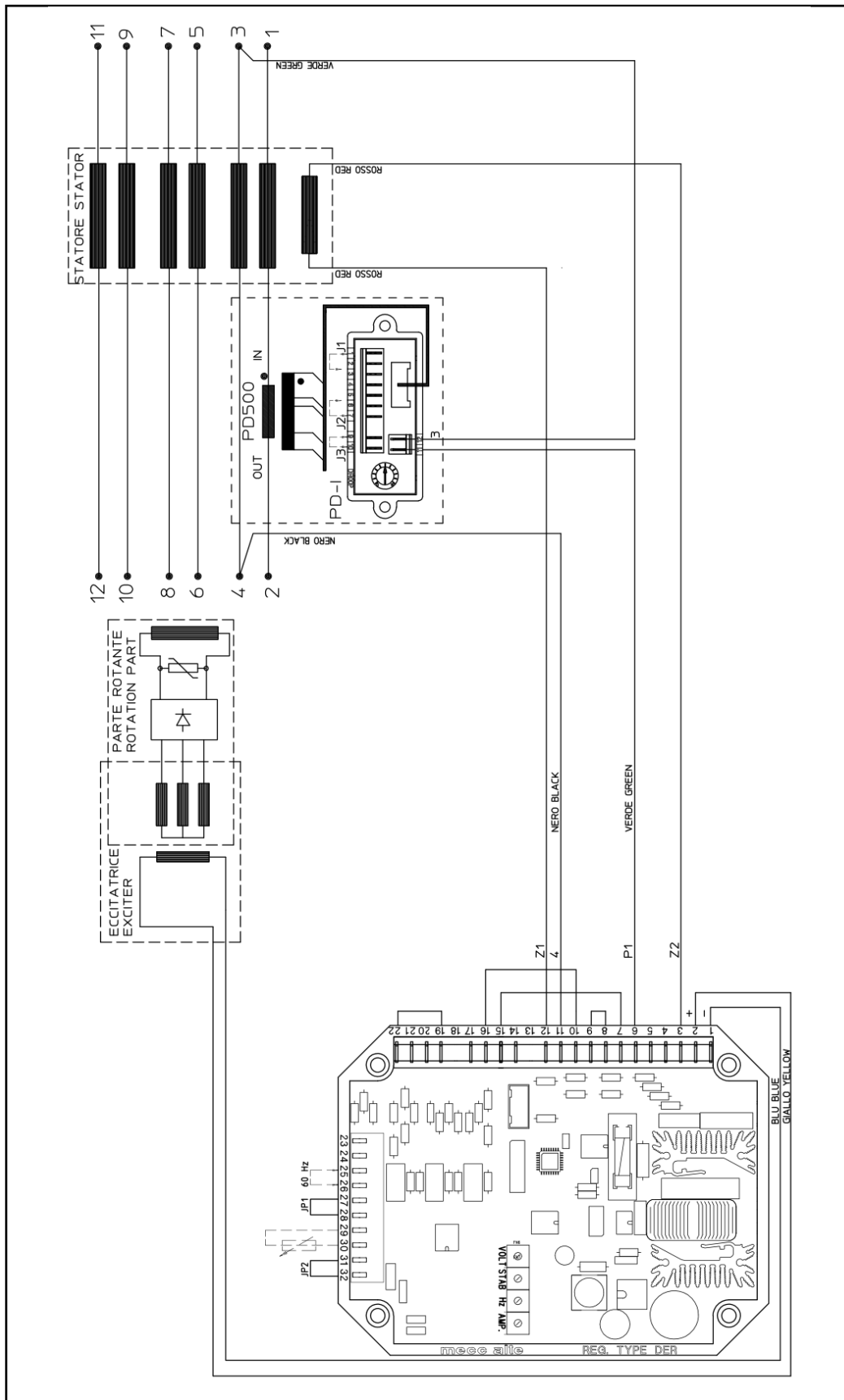

SCC0160/03: Single phase sensing 75V-150V

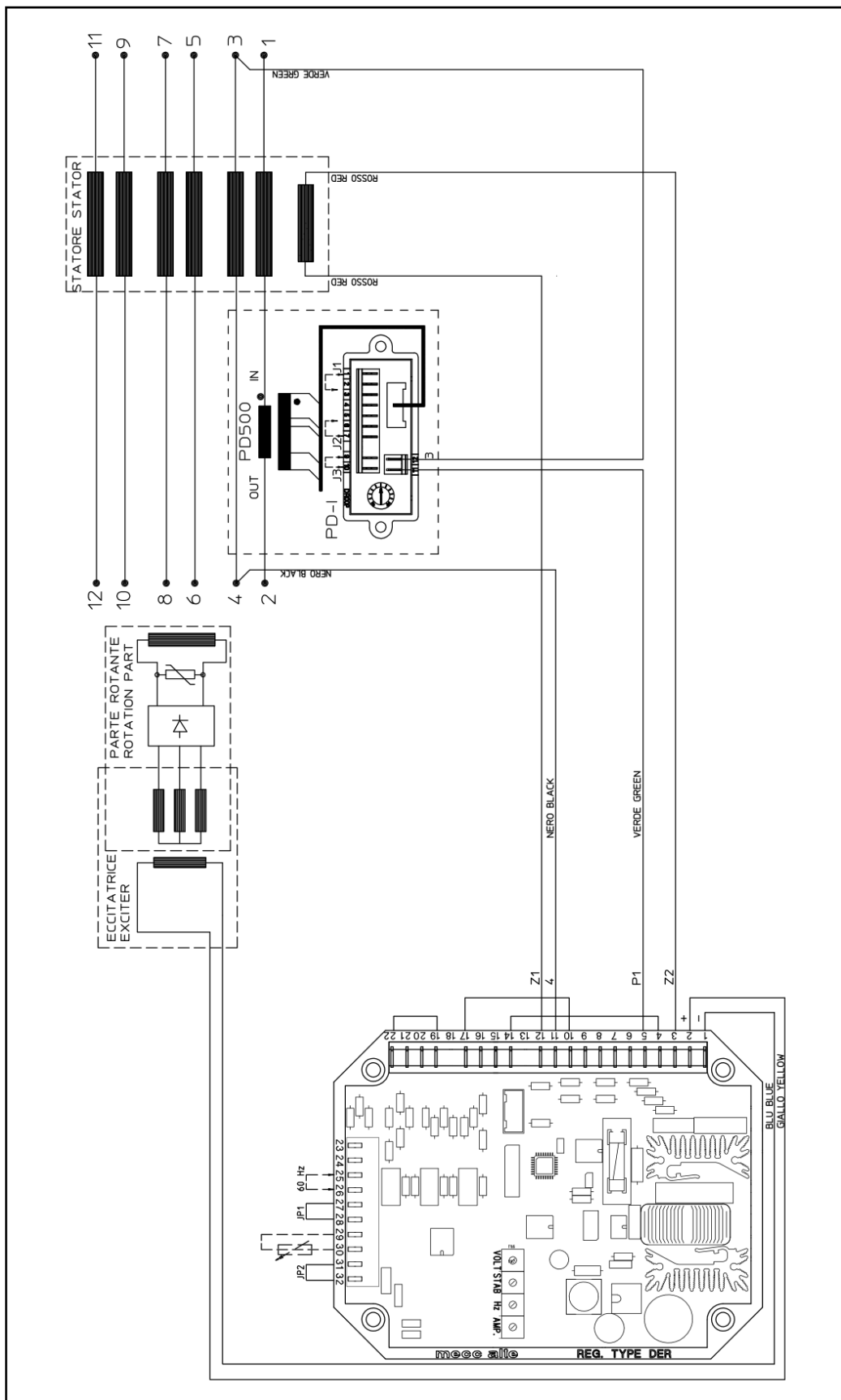

SCC0161/03: Single phase sensing 150V-300V

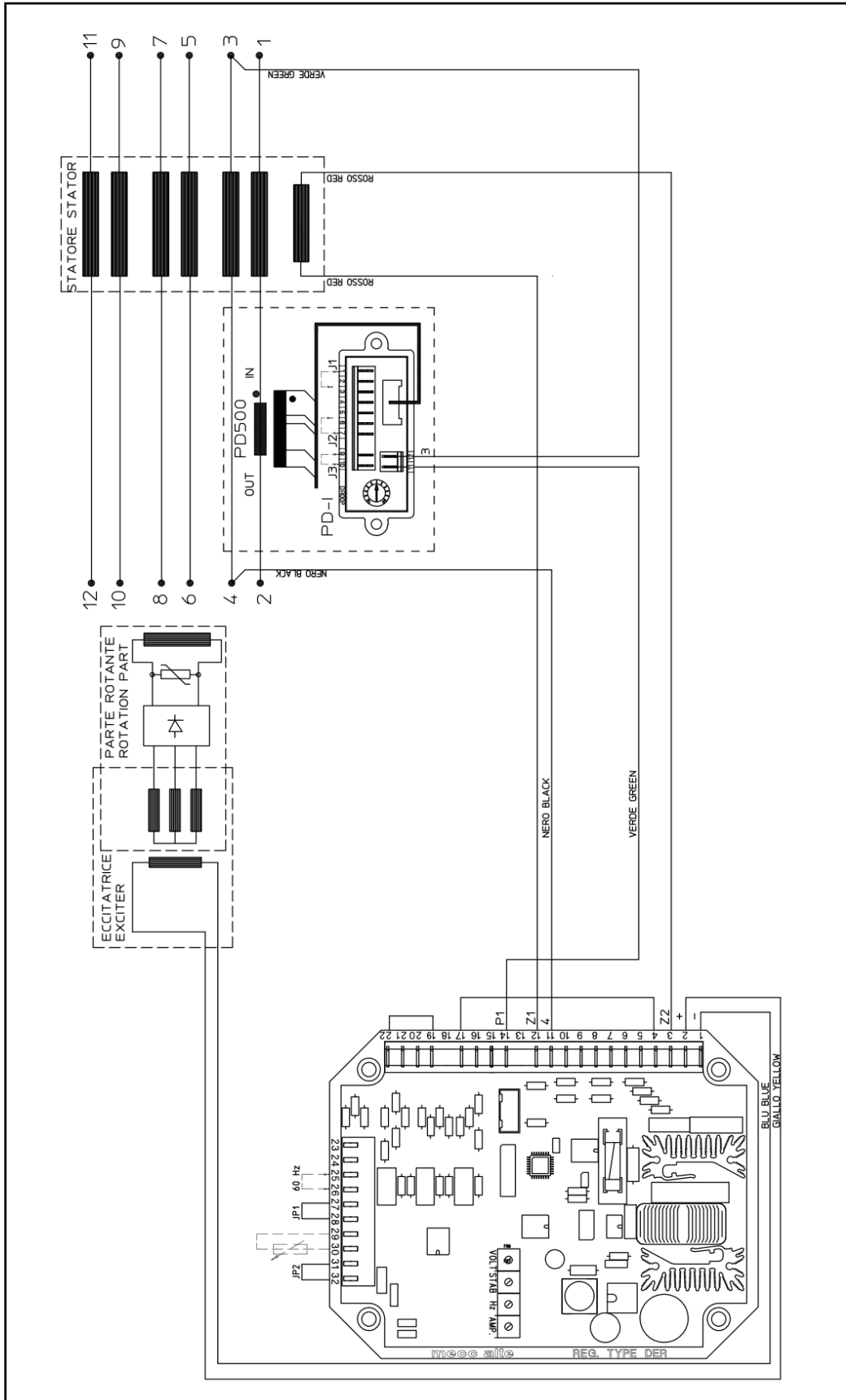

SCC0202/01: Single phase sensing 300V-600V

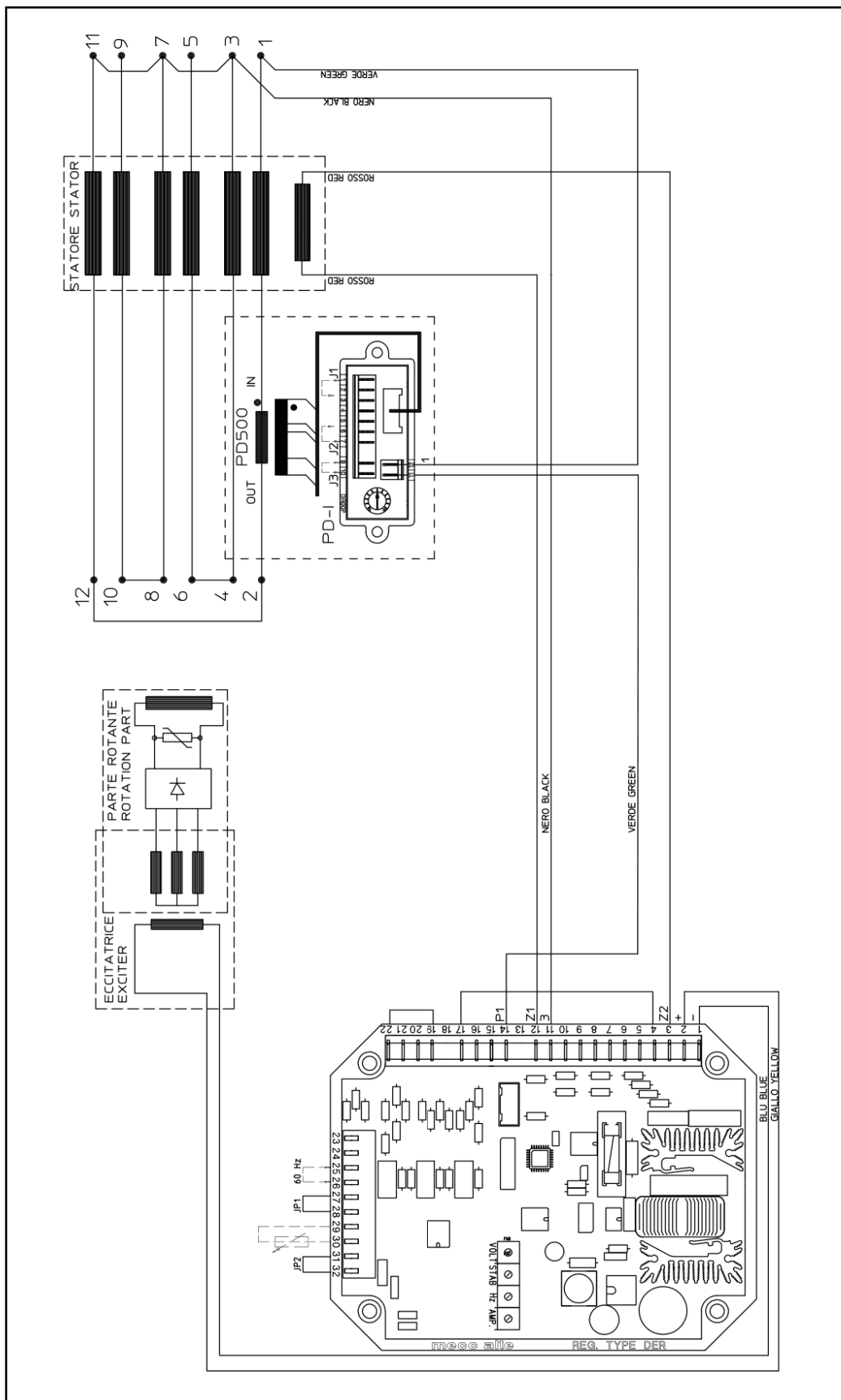

**SCC0203/01: Single phase sensing 300V-600V
(generator in threephase ZIG-ZAG connection)**

8. Remote control of voltage

The Pext input (terminal 30) and $\pm 10V$ (terminal 32) allow to obtain remote control of the output voltage by means of a DC signal or an external potentiometer. The output voltage can be controlled by software as well with the P[19]. The excursion range and gain of the remote control can be set independently by software despite the output voltage control device system used (potentiometer, VDC signal or P[19]). If DC voltage is used, it will take effect if it is within the range 0Vdc/2,5Vdc or -10Vdc/+10Vdc, when connected between terminals 30 and 29 and subjected by jumpers JP1 and JP2; for values exceeding the aforementioned limits (or in the event of disconnection), two options are possible: not to take the set point of external input and return to regulation to the voltage value set with the trimmer (if enabled) or with parameter P[19], or keep the minimum (or maximum) value of voltage that can be reached (see figures 3a and 3b). The two options can be set with the **RAM Voltage CTRL** flag in the **Settings/Advanced** menu corresponding to the bit B7 of the configuration word P[10] (see PARAMETERS AND OPERATIONAL DATA - Para. 2). The setting relative to the Vext input are summarised in table 5.

NOTE: the source of DC voltage must be capable of absorbing at least 2 mA.

In making adjustments it is recommended not to exceed the nominal value of voltage of the alternator beyond $\pm 10\%$

Relationship between analogical input and output voltage

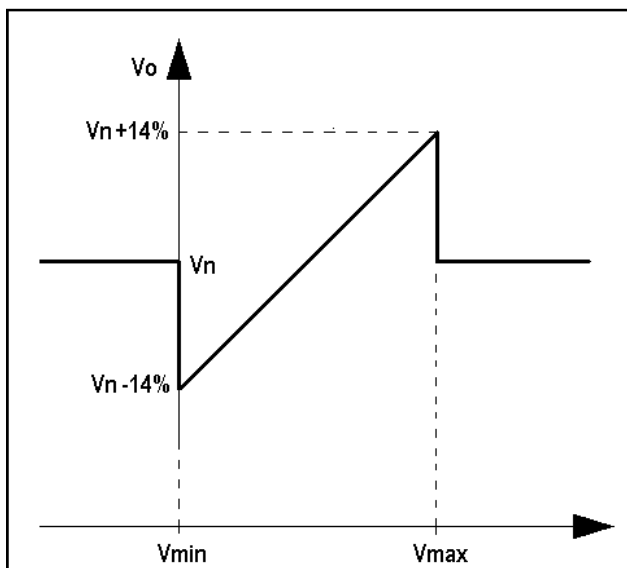

Figure 3a: without saturation of the output voltage upon reaching the input voltage limits.

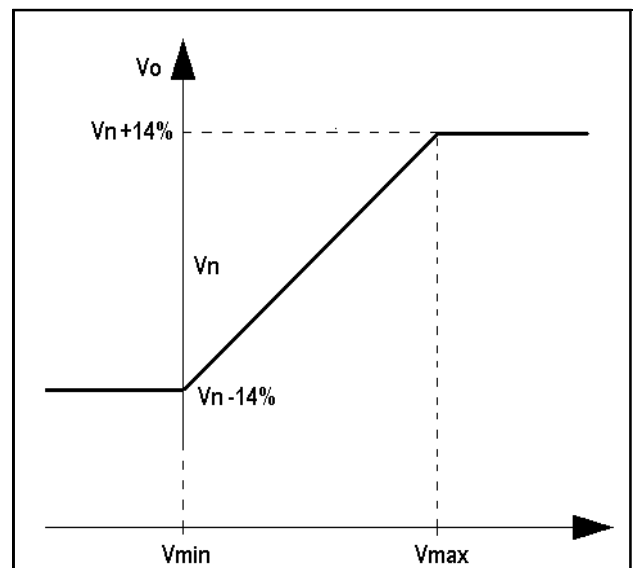

Figure 3b: with saturation of the output voltage upon reaching the input voltage limits.

TABLE 5: HARDWARE AND SOFTWARE CONFIGURATION OF VOLTAGE REMOTE CONTROL

Type	Input	Jumpers		Flags (configuration menu) or Parameter P[10]	
		JP1 (27-28)	JP2 (31-32)	RAM Voltage CTRL	Ext. Input
Potentiometer	0Ext - Pext (29-30)	Close	Close	Disabled (Bit B7=0)	Enabled (Bit B12=1)
0V/2,5V without saturation	0Ext - Pext (29-30)	Close	Close	Disabled (Bit B7=0)	Enabled (Bit B12=1)
0V/2,5V with saturation	0Ext - Pext (29-30)	Close	Close	Enabled (Bit B7=1)	Enabled (Bit B12=1)
-10V/+10V without saturation	0Ext - $\pm 10V$ (29-32)	Open	Open	Disabled (Bit B7=0)	Enabled (Bit B12=1)
-10V/+10V with saturation	0Ext - $\pm 10V$ (29-32)	Open	Open	Enabled (Bit B7=1)	Enabled (Bit B12=1)
Parameter P[15]	EEPROM	Close	Close	Disabled (Bit B7=0)	Disabled (Bit B12=0)
Location L[49]	RAM	Close	Close	Enabled (Bit B7=1)	Disabled (Bit B12=0)

With a 100Kohm linear potentiometer connected as shown in figure 4a, you have the full excursion set with parameter P[16] (with the default value P[16]=4608 there is an excursion of $\pm 14\%$); with a 25Kohm linear potentiometer in series with a 3.9Kohm resistor, connected as shown in figure 4b, the effect of the external potentiometer is cut in half (with the default value P[16]=4608 there is an excursion of approximately $\pm 7\%$).

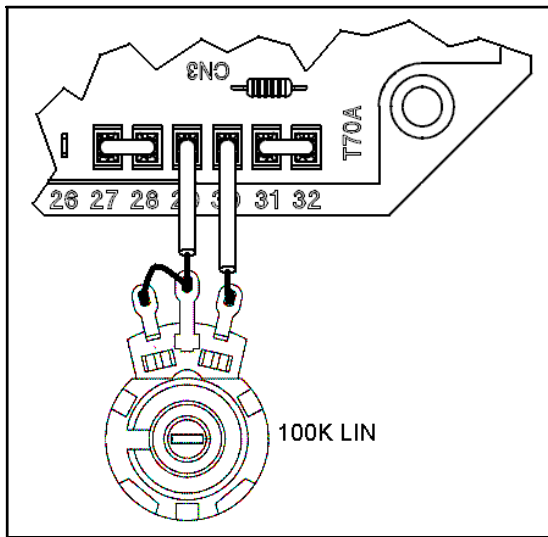

Fig. 4a: 100K external potentiometer connection

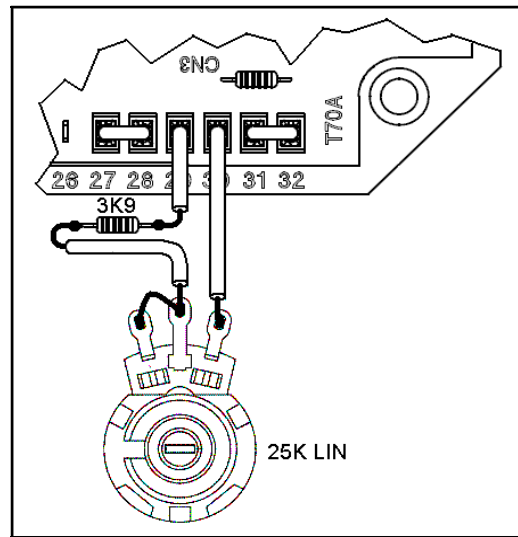

Fig. 4b: 25K external potentiometer connection

9. VOLT, STAB, Hz and AMP Trimmers

The trimmers are enabled by the software DxR_Terminal; if they are not enabled, they do not perform any function.

The **VOLT** trimmer allows adjustment from about 75V to about 150V or from about 150V to about 300V.

The **STAB** trimmer adjusts the dynamic response (statism) of the alternator under transient conditions.

The **Hz** trimmer allows for a variation of the "low speed protection" of up to -20% with respect to the nominal speed value set by the 50/60 jumper (if activated) or by the 50/50 box in the **Settings/UFLO&LAM** menu (at 50 Hz the threshold can be calibrated from 40 Hz to 50 Hz, at 60 Hz the threshold can be calibrated from 48 Hz to 60 Hz).

The **AMP** trimmer adjusts the excitation overcurrent protection intervention threshold.

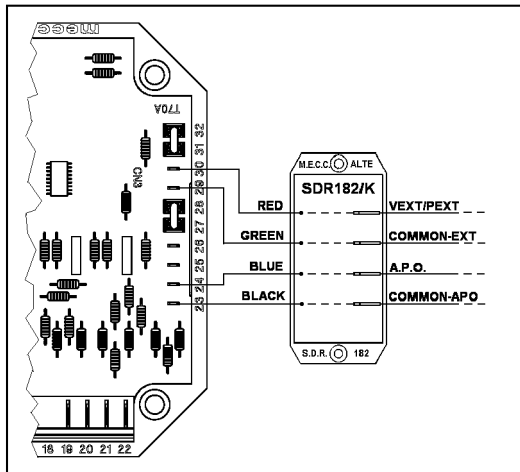

Fig. 5: Connessione filtro EMI SDR182/K

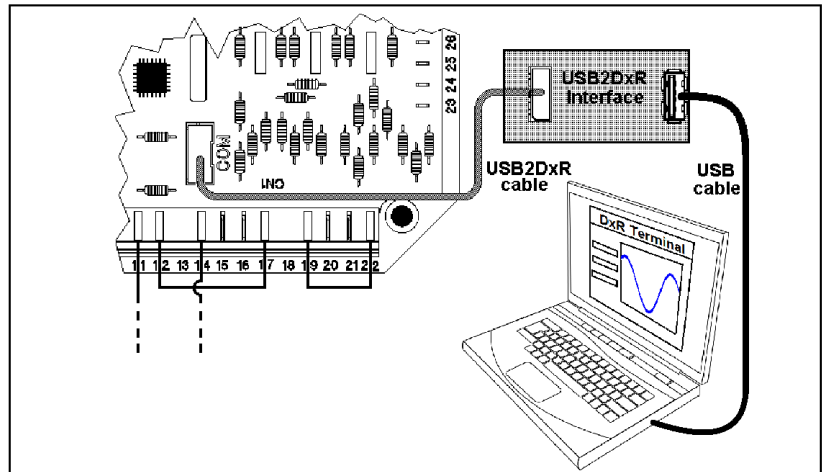

Fig. 6: Connessione tra DER/1 e PC tramite interfaccia digitale USB2DxR

10. USB Communications

The COM connector is RESERVED for connection to the USB2DxR communications module through the dedicated cable provided together with the module (see fig. 6).

For the communication, the regulator implements a subsystem of the ModBus standard; the DER1-USB2DxR system performs a "slave" operation the address of which is stored in the DER1 EEPROM and is set during configuration.

Detailed descriptions of the ModBus commands implemented are into the Technical Guide "Digital Regulators Communication Protocol" available on the web site www.meccalte.com.

The "Master Unit" is made up of a PC or other dedicated equipment and can access the parameters and functions of the regulator.

The master unit has the following possible functions:

- Repetition, or visualisation, of the generator status variables, even from a remote location
- Setting of single parameters
- Uploading and downloading of settings files
- Status readings (alarms, measuring variables)
- Readings of the alarm memory information

PARAMETERS AND OPERATING DATA

1. ModBus registry list

An EEPROM memory is used to store configuration parameters and other information that must not be lost when the generator goes off. Parameters can be read/written and machine operational settings entered through USB connections (with module USB2DxR). Two versions of the regulator are available, called DER1 and DER1/A; they differ primarily in the default value of several parameters. Table 6 shows a complete list of the parameters that can be set, which define all the operational conditions of the regulator.

TABLE 6 : EEPROM SETTING REGISTRIES

Add.	Description of Parameter	Range	Default		NOTES
			DER1	DER1/A	
0	Firmware revision	0..65535	19	19	Reserved - Do not write
1	ModBus slave address	1..31	1	1	Identification of RS485 network (or broadcast)
2	Software configuration	0..65535	16402	18962	Reserved - Do not write
3	Serial number, high part	16bit	0	0	Reserved - Do not write
4	Serial number, low part	16bit	0	0	Reserved - Do not write
5	Three phase sensing calibration	0..32767	16384	16384	Calibration of voltage channels in 3 ph adjustment
6	Single Phase sensing calibration	0..32767	16384	16384	Calibration of voltage channels in 1 ph adjustment
7	Measured voltage calibration	0..32767	16384	16384	Calibration of location L 36 (first "STATUS" box)
8	Current limit time	0..32767	0	0	Duration of limiting in number of periods
9	Current limit level	0..32767	32767	32767	Excitation voltage limit upon start-up
10	Word configuration	16bit	7988	7988	Detailed descriptions paragraph 2 table 7
11	Shift to LEFT proportional gain	0..6	4	5	n=0..6 is equivalent to a multiplication by 2 ⁿ namely 1, 2, 4, 8, 16, 32, 64.
12	Shift to LEFT integral gain	0..6	3	1	
13	Coefficient tying Ki to Kp	0..32767	16384	26624	Coefficient to set Ki and Kp separately
14	Vout / Vaux Ratio	±32767	6000	6000	Limit to voltage reduction as a function of frequency
15	Reference equivalent to Vext	0..32767	16384	16384	Value used if the Vext input and location L[49] are disabled
16	Limitation of Vext Variation	0..6553	4608	4608	Limits the effect of external analogical input (0->0; 4608->14%)
17	APO delay & alarm settings	0..65535	254 ⁽¹⁾	254 ⁽¹⁾	Selects alarms that activate the APO contact and sets the delay intervention
18	Step limitation reference	1..1000	50	50	For rapid variations of voltage setpoint, the passage from one value to another takes place through added or subtracted steps at each period.
19	Vout Reference	0..32767	0	0	Value used if the VOLT trimmer is disabled
20	Stability	0..32767	16384	16384	Value used if the STAB trimmer is disabled
21	Freq. threshold ± 10% freq _{nom}	0..32767	16384	16384	Value used if the Hz trimmer is disabled
22	Excitation overcurrent threshold	0..32767	16384	16384	Value used if the AMP trimmer is disabled
23	V/F Slope	0..32767	9000	9000	V/F curve slope during normal operation
24	V/F curve slope at start up	0..32767	6000	6000	Used only upon start up
25	Short circuit time	0..255	20	20	Operating time with short circuited alternator, expressed in tenths of seconds (0 25.5 seconds) [0=excluding STOP]
26	Overspeed threshold	±32767	0	0	Variation (±10%) of overspeed alarm intervention with respect to the default value of 55/66Hz
27	Underexcitation threshold ⁽¹⁾⁽³⁾	0..32767	512	512	Under-excitation alarm threshold ⁽¹⁾
28	Ki over-excitement Regulator	0..32767	12287	12287	Integral gain of excitation voltage regulator
29	AMP slope (f) ⁽¹⁾⁽³⁾	0..32767	15154	15154	AMP (f) ⁽¹⁾⁽³⁾ overexcitation protection slope
30	Thermal dispersion coefficient	0..65535	63600	63600	Used by AMP alarm temperature estimator
31	Reserved	0..65535	-	-	Do not write

Note: Locations are ordered to separate the parameters of individual regulators (S.N., SW versions and calibration) from settings foreseen, in order to facilitate programming of regulators with the same settings but different S.N., SW versions and calibrations. The parameters from 0 to 9 are adjusted at the factory for each regulator. The parameters from 10 to 30 can therefore be freely copied from one to another.

NOTE (1): starting from rev. 18 of the firmware

NOTE (2): shutdown intervention threshold not to be changed in the versions preceding the 18th

NOTE (3): proportional gain of excitation voltage regulator in the versions preceding the 18th

2. Configuration word (Parameter P[10])

Configuration of the regulator takes place by setting the individual bits of parameter P[10]. Each of them enables or disables at least one function, on the basis of the fact that its value is respectively 1 or 0.

If the "DxR Terminal" programme is used (see technical guide "Interface communication USB2DxR"), the setting is simplified by the use of the dedicated flags in the different menu corresponding to the specific bit which enables/disables each function.

Alternatively, the DER1 can be configured by directly setting the value of the P[10] parameter; in this case the value is calculated before entry, summing the numbers indicated in the column "Value" of Table 7, corresponding to the functions it is desired to enable.

For example, the default configuration calls for the bits B2, B4, B5 and those from B8 to B12 to be enabled. The corresponding value is therefore: $P[10]=4+16+32+256+512+1024+2048+4096=7988$.

TABLE 7 : BIT FUNCTION OF THE CONFIGURATION WORD (PARAMETER P[10])

Bit	Value	Function	Default
B0	1	Not used	0
B1	2	Periodical reference variation	0
B2	4	Automatic voltage offset compensation ⁽¹⁾	1
B3	8	Not used	0
B4	16	Enable hardware jumper 50/60Hz	1
B5	32	Inversion APO ⁽⁴⁾	1
B6	64	Force three-phase sensing	0
B7	128	External location reference L[49] ⁽²⁾ and activation of saturation in the event of overflow ⁽³⁾	0
B8	256	Enable VOLT TRIMMER	1
B9	512	Enable STAB TRIMMER	1
B10	1024	Enable Hz TRIMMER	1
B11	2048	Enable AMP TRIMMER	1
B12	4096	Enable external analogical input	1
B13	8192	Enable external DAC	0
B14	16384	60 Hz setting in the event of disabling of the 50/50 Hz hardware jumper	0
B15	32768	Reserved	0

NOTE (1): only with single-phase reference

NOTE (2): if analogical input is disabled

NOTE (3): for analogical input

NOTE (4): starting from rev. 18 of the firmware

3. RAM location reference, activation of saturation in analogical remote control

The **RAM Voltage CTRL** Flag (corresponding to bit 7 of the P[10] configuration word) performs two functions:

1. If the Pext hardware input is enabled (Flat Ext. Input corresponding to bit 12 of the P[10] configuration word), as previously described, the **RAM Voltage CTRL Flag** activates saturation of output voltage when the analogical control voltage reaches the limit foreseen for input, to which it is applied (see Para. 8 Remote control of voltage).



If saturation is enabled, in the event of removal of the Vext/Pext connection (due to accidental opening, for example) the voltage goes to the maximum value set in parameter P[16] (+14% by default).

2. When Pext is disabled by hardware, the indicated flag defines the value to be used by the software control of the output voltage. If RAM Voltage CTRL is deactivated (B7=0), the non volatile parameter P [15] is used (therefore following shut down and restart of the regulator, the last value memorised remains set): on the start up the location L[49] is initialised with the value of parameter P[15] and is kept aligned to that value. Editing of location L[49] has no effect in this working condition. If RAM Voltage CTRL is active (B7=1) the volatile location L[49] is used for software remote control of the output voltage (when the regulator is energized, the value is stored. If the regulator is shut down, the value is lost). This function is particularly useful for the applications of alternators in parallel with grid, when the regulation of the reactive power exchanged is controlled by means of a third party supplied digital supervisor.

TABLE 8 : REMOTE VOLTAGE CONTROL FLAGS FUNCTION

FLAG RAM Voltage CTRL	P[10] Bit B7	FLAG Ext. Input	P[10] Bit B12	Output voltage control type
<input type="checkbox"/>	0	✓	1	Analogical without saturation
✓	1	✓	1	Analogical with saturation
<input type="checkbox"/>	0	<input type="checkbox"/>	0	Digital - Parameter P[15]
✓	1	<input type="checkbox"/>	0	Digital - Location L[49]

4. Volatile memory addresses

TABLE 9 : VOLATILE MEMORY ADDRESSES				
Add.	Add name	Range	Access	Description
32	VOLT Trimmer	0..32767	Read only	VOLT Trimmer Position
33	STAB Trimmer	0..32767	Read only	STAB Trimmer Position
34	Hz Trimmer	0..32767	Read only	Hz Trimmer Position
35	AMP Trimmer	0..32767	Read only	AMP Trimmer Position
36	First status word	0..3200	Read only	Regulated voltage [tenths of volts]
37	Second status word	0..900	Read only	Frequency [tenths of Hz]
38	Third status word	16bit	Read only	Active alarms
39	Fourth status word	16bit	Read only	Active configuration
40	Commands	16bit	Write	Reserved Word Commands – Do not use
41	Pext/Vext Inputs	0..32767	Read only	Analogical input or external potentiometer value
42	Setpoint	0..32767	Read only	Setpoint value
43	Setpoint	0..32767	Read only	Value modified by regulator in case of alarms, soft-start, etc.
44	Measured Voltage	0..32767	Read only	Internal variable
45	Estimated temperture	0..32767	Read only	Estimates temperature of exciter windings
...
49	Reference corresponding to Vext	0..32767	Write	Used if Vext input is disabled and voltage remote control by RAM location is enabled (P[10]-Bit B7=1)
50	Peak to peak voltage	0..32767	Read only	Internal variable
51	Three phase switch threshold	0..32767	Read only	Internal variable
52	Offset voltage	0..32767	Read only	Internal variable (active only in single phase sensing)
53	$Kp/2^{P[11]}$	0..32767	Read only	Proportional gain not considering factor $2^{P[11]}$ ⁽¹⁾
54	$Ki/2^{P[12]}$	0..32767	Read only	Integral gain not considering factor $2^{P[12]}$ ⁽¹⁾
55	AMP protection threshold	0..32767	Read only	Intervention threshold of overexcitation protection ⁽¹⁾
56	Underexcitation observer	0..32767	Read only	Observer of underexcitation or loss of excitation ⁽²⁾

5. Fourth Status Word (Location L[39])

Location L[39] indicates (almost in real time) the active configuration at any given time; it is not a simple replication of the value recorded in parameter P[10], however, inasmuch as the bits B2, B6 and B14 adjust their value only on the basis of the configuration set, but also of the effective operational status of the DER1 at that time; for example, if the regulator is connected with three phase sensing, even if bit B6 of the configuration word is set on 0 (automatic recognition of single phase – three phase activation), bit B6 of location L[39] will have a value of 1; similarly, if the 60 Hz jumper is engaged and reading is enabled 8Bit B4 of parameter P[10] set on 1), bit B14 of location L[39] will have a value of 1 even if the corresponding bit B14 of the configuration word is set on 0.

The values of the fourth word of status (location L[39]) are shown in table 10, on the basis of the type of the regulation and nominal frequency.

TABLE 10 : STANDARD VALUES OF THE FOURTH STATUS WORD (LOCATION L[39])		
	Rated frequency:	
Sensing	50Hz	60Hz
Single phase	7988	24372 ⁽²⁾
Three phase	8048 ⁽²⁾	24432 ⁽²⁾

TABLE 11 : BIT FUNCTION OF THE FOURTH STATUS WORD L[39] (ACTIVE CONFIGURATION)			
Bit	Function	Value	Default
B0	Not used	1	0
B1	Bit activating a periodical variation of reference voltage	2	0
B2	Bit activating automatic compensation of the offset in voltage acquisition channels	4	0/1 ⁽¹⁾
B3	Not used	8	0
B4	Bit enabling reading of 50/60 Hz jumper hardware	16	1
B5	Inversion APO ⁽²⁾	32	1
B6	Three phase sensing active	64	0
B7	Voltage remote control by RAM location L[49] or input saturation (in case of overflow)	128	0
B8	Bit enabling reading of reference voltage by VOLT Trimmer	256	1
B9	Bit enabling reading of stability parameter by STAB Trimmer	512	1
B10	Bit enabling reading of underspeed protection threshold by Hz Trimmer	1024	1
B11	Bit enabling reading of excitation current threshold by AMP Trimmer	2048	1
B12	Bit enabling reading of external voltage input	4096	1
B13	Bit enabling DAC	8192	0
B14	60Hz active setting (jumper 60Hz closed and/or 60Hz active setting on configuration menu) ⁽³⁾	16384	0/1 ⁽¹⁾
B15	Reserved	32768	0

NOTE (1): depending on the sensing and nominal frequency

NOTE (2): starting from revision 18 of the firmware

NOTE (3): software configuration, with jumper 50/60 disabled

SETTING OF VOLT, STAB, AMP and Hz PARAMETERS.

1. Voltage

1.1 Setting voltage.

Setting can take place through the trimmer or software: on sensing inputs 6/7 – 10/11/12 (with bridge 8-9), 15-16 and 20-21, the voltage can be set between 75÷150 Vac (scale H); on sensing inputs 4/5 - 9/10/11/12, 14-17 and 19-22 between 150÷300 Vac (scale F).

There are two ways to set from minimum to maximum value:

1. With the VOLT trimmer, which must be enabled by the **Settings/potentiometers** menu of DxR Terminal software
2. With parameter P[19] (The Volt trimmer must be enabled from the **Settings/Potentiometers** menu: the value 0 corresponds to minimum voltage, 16384 corresponds to the intermediate value (respectively 112.5 V and 225 V), while 32767 corresponds to maximum voltage.

The setting is facilitated using the software DxR Terminal, through **Settings/Potentiometers menu**.

It is possible to vary voltage with respect to the value set, with the Pext input (terminals 29-30) if enabled from the area Pext/Vext in the **Settings/Advanced** menu, with a 25Kohm or 100Kohm potentiometer, with a range of variation that can be programmed up to ±100% (parameter P[16]. The default setting is ± 14%, even if it is opportune not to exceed ±10%). Alternatively, variation can be made with continuous voltage applied on Pext (terminal 30) or ±10V (terminal 32), based on the value of that voltage. If the Pext voltage is disabled, it is possible to vary the voltage with parameter P[15] or location L[49]. For additional details see the paragraph "Remote control of voltage".

1.2 Soft Start

In the event of fast start up of the prime mover or sudden regulator excitation with the generator running at nominal speed an uncontrolled regulator could result in a temporary generator overvoltage or in a transitory prime mover overload due to the high peak of excitation current..

These effects can be minimised by setting parameter "Delay" and "Excitation Limit" in the area "Soft-Start" of the **Settings/Advanced** menu, corresponding to parameters P[8] and P[9] : during starting, they determine a limit of the excitation current.

Parameter P[8] sets the duration of the excitation current limitation, namely the value of the parameter corresponds to the number of periods in which the limitation is active. The default value is P[8]=0 which corresponds to deactivation of the soft start. Considering that in most cases the alternator is already at nominal speed, an estimate in temporal terms (corresponding to the setting "Delay" in Soft-Start area) for 4 pole machines, may be obtained with the formula:

$$t_{lim} = P[8] \cdot \frac{1}{f_n} = P[8] \cdot \frac{30}{\omega_n} \quad \text{Where } f_n = \text{nominal frequency in Hz or } \omega_n = \text{nominal speed in R.P.M}$$

The parameter P[9] sets the excitation current limit: the value P[9]=0 is setting to zero the excitation current, while the maximum value P[9]=32767 is removing the current limitation. The default value is P[9]=32767. When the interval of action of the soft start has been exceeded, the output voltage moves to the value set. The rapidity of the change is set by parameter P[18] (see paragraph on "Slow voltage variations")



The optimal values of "Delay" and "Excitation limit" (parameters P[8] and P[9]) depend a great deal on the type of alternator and final application and it must be found through experimentation. An inappropriate setting of parameters P[8] and P[9] could cause failure of the alternator to excite itself.

By way of example, for high power alternators of the ECO46 series, the following settings may be experimented: Delay=1280ms (P[8]=64) and Excitation limit=50% (P[9]=16384); for low power alternators of the ECP3 series, the effects of a reduction of both the duration and limitation of the current may be experimented, such as Delay=320ms (P[8]=16) and Excitation limit=3,72% (P[9]=4096).

1.3 Slow voltage variations

In the event of rapid variation of the reference, a procedure of "slow" variation has been foreseen: in response to a step variation, parameter P[18] determines the rapidity with which the transition is made. A value of 1 involves the slowest possible variation; a value exceeding 100 involves an almost immediate variation. The value 0 disables any variation.

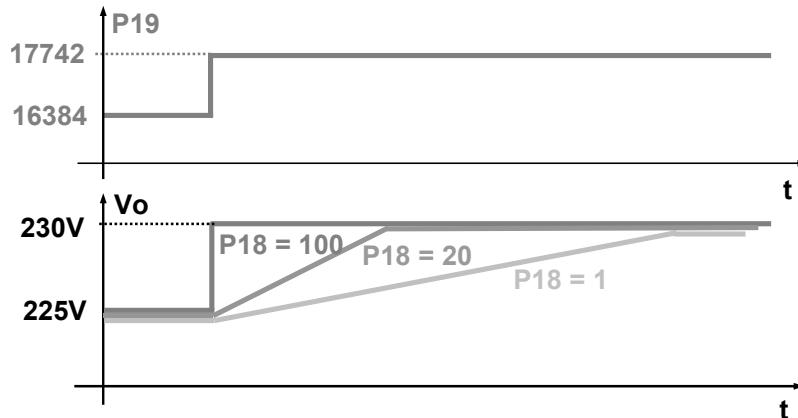

fig. 7

2. Stability

2.1 Adjustment of stability

The regulator diagram is shown in figure 8.

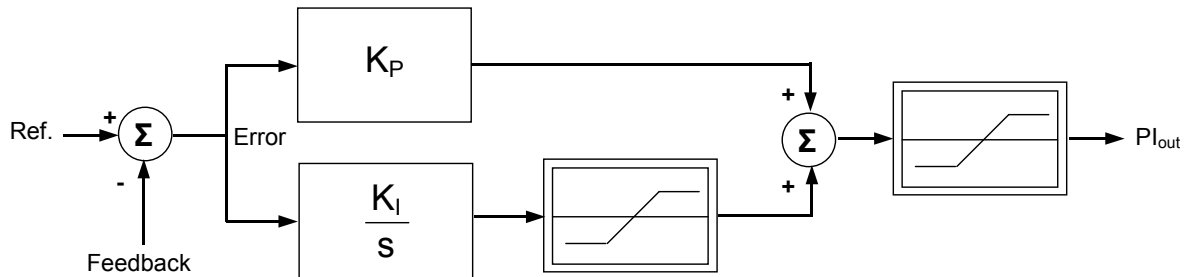

figure 8 : Regulator Diagram

The values of the proportional and integral gain (K_P and K_I respectively) depend on the position of the STAB trimmer if enabled, or the value of parameter P[20] if the trimmer is disabled. The value of the proportional gain K_P also depends on the value of the P[11] parameter. The value of the integral gain K_I depends on the values of parameters P[12] and P[13] and, only for the standard DER1 (grey box) with the STAB trimmer enabled, even on the 50/60Hz⁽¹⁾ setting. In the other DER1 versions, for example DER1/A (blue box), the integral gain K_I does not differ no matter how the 50/60Hz⁽⁴⁾ setting is set.

The numeric elaborations carried out by the DER1 for obtaining the proportional and integral gain values are given in the block diagrams in figures 8a⁽²⁾, 8b⁽²⁾ and 8c.

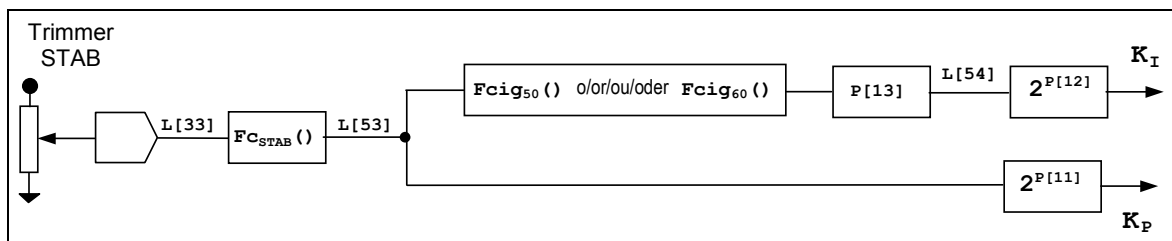

fig. 8a: drawing of the numeric elaboration of the proportional and integral gain by a DER1 (standard) with the STAB trimmer enabled

If the STAB trimmer is enabled (STAB Flag Trimmer present) its angular position, available at location L[33], is transformed by the $FC_{STAB}^{(2)}$ function into the numeric value available at location L[53]⁽³⁾ (figs. 8a and 8b). If the STAB trimmer is disabled, the value of location L[53]⁽³⁾ directly becomes the value set using the P[20] parameter (fig. 8c).

The proportional gain K_P is obtained by multiplying the value of location L[53]⁽³⁾ by a coefficient that depends on the value given in parameter P[11]⁽⁴⁾.

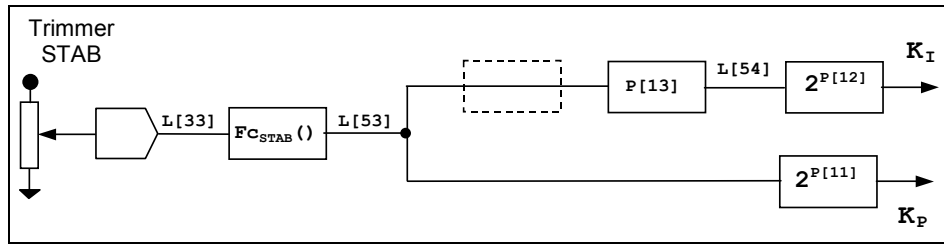

fig. 8b: drawing of the numeric elaboration of the proportional and integral gain by a DER1/A with the STAB trimmer enabled

The integral gain, available at location L[54]⁽³⁾ minus the multiplication by a coefficient, depends on the value of the proportional gain at location L[53]⁽³⁾; in the standard DER1 (grey box) with the STAB trimmer enabled (STAB Flag Trimmer present) the value of location L[53]⁽³⁾ at 50Hz is transformed by the function $F_{cig_{50}}^{(2)}$ and by the multiplication of the value of parameter P[13], in the numeric value available at location L[54]⁽³⁾; at 60Hz the transformation function is $F_{cig_{60}}^{(2)}$, different from that at 50Hz, (fig. 8a); in the other versions of the DER1 (fig. 8b), for example DER1/A (blue box), or if the STAB trimmer is disabled⁽⁴⁾ (fig. 8c), not only is there a difference between the integral value at 50Hz and at 60Hz, but even the value of location L[54]⁽³⁾ is obtained by simply multiplying the proportional gain at location L[53]⁽³⁾ by the value of parameter P[13].

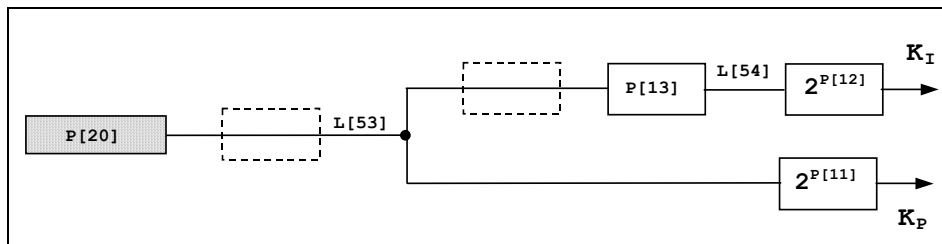

fig. 8c: drawing of the numeric elaborations of proportional and integral gain by all DER1 with STAB trimmer disabled

In both cases, the effective integral gain K_I is obtained by multiplying the value of location L[54]⁽³⁾ by a coefficient that depends on the value given in parameter P[12]⁽⁴⁾.

The mentioned coefficients can take on values of 1, 2, 4, 8, 16, 32 or 64 according to the values written in parameters P[11] (for proportional gain) and P[12] (for integral gain); these values represent the value assigned to base 2 (fixed) to obtain the required coefficient (e.g. parameter P[11] = 4 => multiplication coefficient of the proportional gain = $2^4 = 16$, P[12] = 3 => multiplication coefficient of the integral gain = $2^3 = 8$).

The following tables show, for every three-phase machine on 50Hz and 60Hz, the STAB trimmer calibration which allows increased speed of response to the transistor with the generator in stand-alone operation. In case of different applications (for example alternators reconnected in single-phase, in parallel among them or in parallel with the grid, with motors having less than 4 cylinders and so on) it may be necessary to readjust the STAB trimmer calibration.

If the voltage cannot be stably adjusted for permanent operation and/or in the transient by the STAB trimmer settings, it may be necessary to vary one or more stability adjustment parameters: P[11], P[12] and P[13] the description of which is given in table 6.

NOTE ⁽¹⁾ Starting from Rev. 15 of the firmware

NOTE ⁽²⁾ The FC_{STAB} , $F_{cig_{50}}$ and $F_{cig_{60}}$ functions are not implemented in the DER1s with firmware up to version 14, and in the block diagram they are considered as identities, i.e. $L[53]^{(3)} = FC_{STAB}(L[33]) = L[33]$ e $F_{cig_{60}}(L[53]) = F_{cig_{50}}(L[53]) = L[53]^{(3)}$.
With these regulators the STAB trimmer needs to be rotated by less than two notches counted clockwise.

NOTE ⁽³⁾ Location available to the user from firmware Rev. 15.

NOTE ⁽⁴⁾ Structure valid also for DER1s with firmware up to version 14 but without location L[53] and L[54] availability

TABLE 12 ECO/ECP SERIES: RECOMMENDED SETTINGS OF DER1 STAB TRIMMER Fw Rel. ≥ 15

Alternator		Nominal frequency = 50Hz						
Type	Pole	S [KVA]	Singlephase			Threephase		
			STAB	L[33]	L[53]	STAB	L[33]	L[53]
ECO38-1S/4 A ⁽¹⁾	4	180	n.d.	n.d.	n.d.	6	16384	8192
ECO38-2S/4 A ⁽¹⁾	4	200	n.d.	n.d.	n.d.	8	24191	17859
ECO38-3S/4 A ⁽¹⁾	4	225	n.d.	n.d.	n.d.	8,5	26176	20910
ECO38-1L/4 A ⁽¹⁾	4	250	n.d.	n.d.	n.d.	n.d.	n.d.	n.d.
ECO38-2L/4 A ⁽¹⁾	4	300	n.d.	n.d.	n.d.	8	24191	17859
ECO38-3L/4 A ⁽¹⁾	4	350	11	32704	32640	9	28096	24090
ECO40-1S/4 B ⁽²⁾	4	400	11	32704	32640	9	28096	24090
ECO40-2S/4 B ⁽²⁾	4	450	11	32704	32640	8,5	26176	20910
ECO40-3S/4 B ⁽²⁾	4	500	9,5	30077	27607	9	28096	24090
ECO40-1L/4 B ⁽²⁾	4	550	9	28096	24090	n.d.	n.d.	n.d.
ECO40-1.5L/4 B ⁽²⁾	4	620	9	28096	24090	9,5	30077	27607
ECO40-2L/4 B ⁽²⁾	4	680	11	32704	32640	n.d.	n.d.	n.d.
ECO40-VL/4 B ⁽²⁾	4	720	9,5	30077	27607	n.d.	n.d.	n.d.
ECO43-1S/4 A ⁽²⁾	4	800	9	28096	24090	n.d.	n.d.	n.d.
ECO43-2S/4 A ⁽²⁾	4	930	9	28096	24090	n.d.	n.d.	n.d.
ECO43-1L/4 A ⁽²⁾	4	1100	9	28096	24090	n.d.	n.d.	n.d.
ECO43-2L/4 A ⁽²⁾	4	1300	9	28096	24090	n.d.	n.d.	n.d.
ECO43-VL/4 A ⁽²⁾	4	1400	9	28096	24090	n.d.	n.d.	n.d.
ECO46-1S/4 A ⁽²⁾	4	1500	8	24191	17859	n.d.	n.d.	n.d.
ECO46-1.5S/4 A ⁽²⁾	4	1650	9,5	30077	27607	9,5	30077	27607
ECO46-2S/4 A ⁽²⁾	4	1800	11	32704	32640	9,5	30077	27607
ECO46-1L/4 A ⁽²⁾	4	2100	9,5	30077	27607	n.d.	n.d.	n.d.
ECO46-1.5L/4 A ⁽²⁾	4	2300	11	32704	32640	9	28096	24090
ECO46-2L/4 A ⁽²⁾	4	2500	9	28096	24090	n.d.	n.d.	n.d.

Alternator		Nominal frequency = 60Hz						
Type	Poli	S [KVA]	Singlephase			Threephase		
			STAB	L[33]	L[53]	STAB	L[33]	L[53]
ECO38-1S/4 A ⁽¹⁾	4	216	n.d.	n.d.	n.d.	n.d.	n.d.	n.d.
ECO38-2S/4 A ⁽¹⁾	4	240	n.d.	n.d.	n.d.	n.d.	n.d.	n.d.
ECO38-3S/4 A ⁽¹⁾	4	270	n.d.	n.d.	n.d.	8	24191	17859
ECO38-1L/4 A ⁽¹⁾	4	300	n.d.	n.d.	n.d.	n.d.	n.d.	n.d.
ECO38-2L/4 A ⁽¹⁾	4	360	n.d.	n.d.	n.d.	n.d.	n.d.	n.d.
ECO38-3L/4 A ⁽¹⁾	4	420	8,5	26176	20910	9	28096	24090
ECO40-1S/4 A ⁽²⁾	4	480	n.d.	n.d.	n.d.	n.d.	n.d.	n.d.
ECO40-2S/4 A ⁽²⁾	4	540	n.d.	n.d.	n.d.	n.d.	n.d.	n.d.
ECO40-3S/4 A ⁽²⁾	4	600	n.d.	n.d.	n.d.	n.d.	n.d.	n.d.
ECO40-1L/4 A ⁽²⁾	4	660	8,5	26176	20910	n.d.	n.d.	n.d.
ECO40-1.5L/4 A ⁽²⁾	4	744	n.d.	n.d.	n.d.	n.d.	n.d.	n.d.
ECO40-2L/4 A ⁽²⁾	4	816	n.d.	n.d.	n.d.	n.d.	n.d.	n.d.
ECO40-VL/4 A ⁽²⁾	4	864	9	28096	24090	n.d.	n.d.	n.d.
ECO43-1S/4 A ⁽²⁾	4	960	8,5	26176	20910	n.d.	n.d.	n.d.
ECO43-2S/4 A ⁽²⁾	4	1116	8,5	26176	20910	n.d.	n.d.	n.d.
ECO43-1L/4 A ⁽²⁾	4	1320	8,5	26176	20910	n.d.	n.d.	n.d.
ECO43-2L/4 A ⁽²⁾	4	1560	8	24191	17859	n.d.	n.d.	n.d.
ECO43-VL/4 A ⁽²⁾	4	1700	n.d.	n.d.	n.d.	n.d.	n.d.	n.d.
ECO46-1S/4 A ⁽²⁾	4	1800	n.d.	n.d.	n.d.	n.d.	n.d.	n.d.
ECO46-1.5S/4 A ⁽²⁾	4	1980	n.d.	n.d.	n.d.	9	28096	24090
ECO46-2S/4 A ⁽²⁾	4	2160	9,5	30077	27607	9	28096	24090
ECO46-1L/4 A ⁽²⁾	4	2520	8,5	26176	20910	n.d.	n.d.	n.d.
ECO46-1.5L/4 A ⁽²⁾	4	2760	n.d.	n.d.	n.d.	8,5	26176	20910
ECO46-2L/4 A ⁽²⁾	4	3000	n.d.	n.d.	n.d.	n.d.	n.d.	n.d.

NOTE (1) DER1: P[11] = 4, P[12] = 3, P[13] = 16384, with trimmer STAB enabled
 NOTE (2) DER1/A: P[11] = 5, P[12] = 1, P[13] = 26624, with Fcig₆₀(L[53]) = Fcig₅₀(L[53]) = L[53]

3. EXCITATION OVERCURRENT

3.1 Description

The DER1 regulator is equipped with an excitation (main rotor) winding temperature estimator. An estimate of the temperature (in relative values) is available in real time (and it can be read) in location 45; in the lower part of the main window of the DxR terminal software there is a graphic representation of location 45. The progress of the temperature is of the exponential type (see figure 9).

Through parameter P[22] or the AMP trimmer, it is possible to define a limit (which involves intervention of alarm 5) to the excitation voltage and therefore to the temperature.

The function of this alarm is not only to signal an excessive temperature, but it also has an active function in reducing the cause. In fact, an adjustment ring takes control of the voltage generated when the threshold set is exceeded: This reduces the voltage to the point of reducing the excitation current by a value compatible with the ability of thermal dissipation of the machine. The stability of the regulation in case of overexcitation alarm, if necessary, may be adapted to the application by varying the value of parameter 28⁽⁵⁾

For an increased protection of the electrical machine, starting from rev. 18 of the firmware, the excitation overcurrent protection was extended to the whole speed interval (frequency) of the alternator, particularly for the lower frequencies, to a preset threshold (56.7Hz with the jumper inserted between the 25 and 26 terminals of connector CN1, if enabled, or, otherwise, if the 50/60, 49Hz setting is enabled) the protection intervenes with an effective threshold (relative to the one set through the AMP trimmer or parameter 22) reduced proportionally to the frequency.

The extent of this reduction depends on parameter 29 which is by default set to an adequate value for the standard alternators, used in three-phase in nominal voltage.

An increment of the value of P[29] determines a bigger reduction of the intervention threshold, based on the frequency reduction, a decrease of the value of P[29] determines a smaller reduction of the intervention threshold.

Caution !

If the magnetic gain of the alternator is high, unstable events may occur when the protections intervenes, therefore it is necessary to adjust parameter 28 (usually by reducing its value).

When the alternator works with reduced load and speed, overheating, which is dangerous to the integrity of the machine, might occur, if the overcurrent protection threshold is not sufficiently reduced when reducing the frequency.

As you can see in figure 9, when the estimated temperature (represented by the continuous line) reaches the threshold value, the reduction of excitation current (and consequent drop in voltage generated) brings about the stabilisation of the temperature near a limit value.

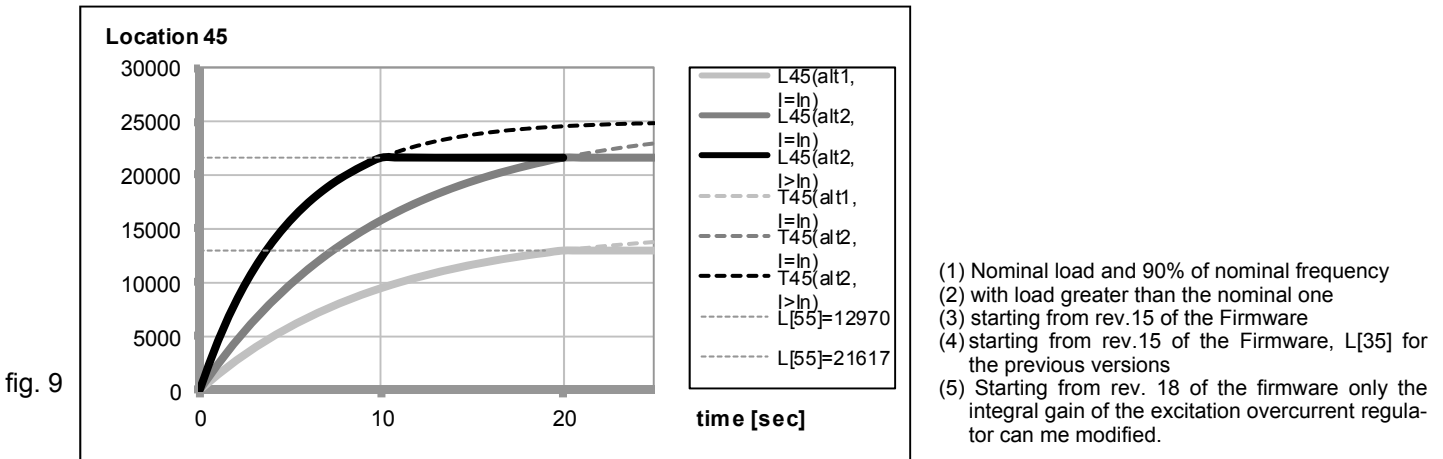

Curve Description

L[45] (alt1, I=In) : value read at location L[45] with a certain alternator⁽¹⁾

L[45] (alt2, I=In) : value read at location L[45] with a second alternator of a different type⁽¹⁾

L[45] (alt2, I>In) : value read at location L[45] with the second alternator during overloading⁽²⁾

T[45] (alt1, I=In) : value that would be read at location L[45] with the first alternator, without protection⁽¹⁾

T[45] (alt2, I=In) : value that would be read at location L[45] with the second alternator, without protection⁽¹⁾

T[45] (alt2, I>In) : value that would be read at location L[45] with the second alternator during overloading, without protection⁽²⁾.

L[55]=12970 : Represents the value of the current limit set using the AMP trimmer or the P[22] parameter for the first alternator⁽³⁾

L[55]=21617 : Represents the value of the current limit set using the AMP trimmer or the P[22] parameter for the second alternator⁽³⁾

3.2 Calibration with a supervision unit

To calibrate the overload protection, when the machine is cold, perform the following procedure:

- 1) turn the AMP trimmer fully clockwise (if enabled from the **Settings/Potentiometers** menu) or write 32676 in location 22
- 2) feed the alternator an overload having $\cos\phi = 0.8$ or $\cos\phi = 0$ respectively equal to 125% or 110% of the nominal load
- 3) read the value displayed at location 45 2 minutes after overload application
- 4) if the AMP trimmer is enabled turn it anti-clockwise until the value read at location 55⁽⁴⁾ becomes equal to the value read at point 3 (location 45); the operation is simplified a lot by using the DxR terminal software which provides, in the lower part of the main window, a graphic representation of the time evolution of locations 45 ("real excitation", red line) and 55 ("excitation threshold" - yellow line): the intervention threshold must be calibrated so that the yellow line should intersect the red line when, from the application of the overload, the time specified at point 3 has passed.
- 5) if the AMP trimmer is not enabled, write the value read at point 3 (location 45) in location 22.
- 6) Alarm 5 should set off (visible both on the main panel of the DxR Terminal and through a change in the LED flash) and the voltage should start to decrease
- 7) If the load is removed, alarm 5 disappears after a few seconds and the generator voltage goes back to the nominal value.

3.3 Calibration without a supervision unit

NB: this calibration can be performed only if the AMP trimmer was previously enabled.

To calibrate the overload protection, perform the following procedure:

- 1) turn the AMP trimmer fully clockwise
- 2) feed the alternator an overload having $\cos\phi = 0.8$ or $\cos\phi = 0$ respectively equal to 125% or 110% of the nominal load
- 3) after two minutes slowly turn the AMP trimmer anti-clockwise until you get a reduction of the generator's voltage value and the activation of alarm 5 (visible through a change in the LED flash)
- 4) Calibrate the AMP trimmer so as to get an output voltage value of 97% of the nominal value: alarm 5 is still active.
- 5) If the load is removed, alarm 5 disappears after a few seconds and the generator voltage goes back to the nominal value.



NOTES: If the machine is used in single phase or voltages different to the ones set by the producer, a recalibration of the overexcitation protection might be necessary.
If it is not possible to apply the prescribed overload, the overexcitation condition may be simulated by adequately increasing the regulated voltage so as to get an excitation current equivalent to the overload current.

4. Underspeed

4.1 Description

For speeds lower than a programmable threshold, the machine voltage is no longer constant, but is regulated proportionately with the frequency at a ratio, which is also programmable, as shown in figure 10a e 10b. The intervention threshold depends upon:

- the status of jumper 50/60 (terminals 25 and 26) if enabled from the **Settings/UFLO&LAMS** Menu.
- the status of the 50/60 setting in the **Settings/UFLO&LAMS** Menu
- the position of the Hz trimmer if enabled from the **Settings/Potentiometers** Menu
- the value entered at parameter P[21] (ref. **Settings/UFLO&LAMS** menu or area Transmit/Receive of Settings/Advanced menu).

Activation of the function with voltage proportionate to the frequency is signalled by activation of alarm 6 (visible from the DER1 Terminal control panel and due to a change in the flashing indicator light).

Parameter P[21](equivalent to the Hz trimmer) sets the Underspeed protection intervention threshold; if this is set on 16384, the protection cuts in at 45 Hz (if the 50/60 jumper and 50/60 flag in the **Settings/UFLO&LAM** menu are not present) or at 54 Hz (if the 50/60 jumper is enabled or the 50/60 flag is active in the **Settings/UFLO&LAM** Menu). Values between 0 and 16384 proportionately lower the threshold, respectively to 40 Hz and 48 Hz; values between 16384 and 32767 proportionately raise the threshold, respectively to 50 Hz and 60 Hz.

Once the underspeed protection has intervened, the frequency is proportionately reduced, as indicated in figure 9a and 9b.

Parameter P[23] sets the slope of the voltage/frequency curve; the default value is 9000. An increase in the value of P[23] involves a greater reduction of the voltage as a function of the reduction in frequency. A decrease in the value of P[23] involves a lower reduction of the voltage until the limit of P[23]=0, which means that there is no reduction in voltage. . The above-mentioned calibrations are simplified a lot by using the DxR terminal software which allows, in the **Settings/UFLO&LAMS** menu, through a graphic interface, to change parameters 21 and 23 (with a concurrent disabling of the Hz trimmer) providing the preview of the V/f ratio in the setting phase.



WARNING: Overheating could occur, which is dangerous for the machine, if the voltage is not lowered enough to decrease the excitation when the alternator is functioning at a reduced speed.

4.2 Calibration with a supervision unit

Use the following procedure in order to calibrate the underspeed protection:

- 1) If the machine has to operate at 60 Hz, make sure the bridge, between terminals 25 and 26 is inserted, or activate 50/60 (ref. **Settings/UFLO&LAMS** menu).
- 2) If the Hz trimmer is enabled, the value of the protection intervention threshold is read at location L[34], otherwise it is entered directly at parameter P[21].

The value 16384 entered at parameter P[21] (or read at location L[34]) corresponds to an intervention at 45/54 Hz (depending on whether 50/60 is activated or not).

Values between 0 and 16384 correspond to an intervention that varies from 40/48 Hz to 45/54Hz.

Values between 16384 and 32767 correspond to an intervention that varies from 45/54 Hz to 50/60Hz.

The operation is much facilitated by the use of the DxR terminal software which provides a graphic representation of the time evolution of the measured frequency (red line) and of the intervention threshold (green line)

- 3) when the speed decreases under the threshold value the voltage of the generator starts to diminish and alarm 6 is simultaneously visualized on the LED and on the main window of the DxR Terminal software
- 4) By increasing speed, the generator voltage will normalise and the 6 alarm will disappear.

4.3 Calibration without a supervision unit

NOTE: This calibration can be performed only if the Hz trimmer and 50/60 jumper have been previously enabled.

Use the following procedure in order to calibrate the under speed protection:

- 1) Rotate the Hz trimmer entirely in the counter clockwise direction.
- 2) If the machine has to operate at 60 Hz, ensure that the bridge is inserted between terminals 25 and 26
- 3) Bring the generator to 90% of the nominal speed.
- 4) Slowly turn the “Hz” trimmer, rotating it clockwise until the generator voltage begins to drop and ascertain that the indicator light simultaneously begins flashing rapidly.
- 5) By increasing speed, the generator voltage will normalise and the alarm will disappear.
- 6) Set the speed to the nominal value

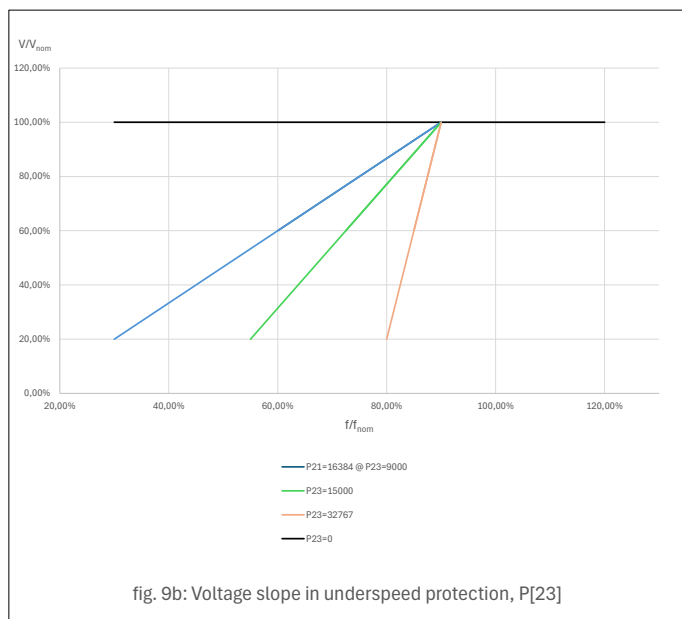
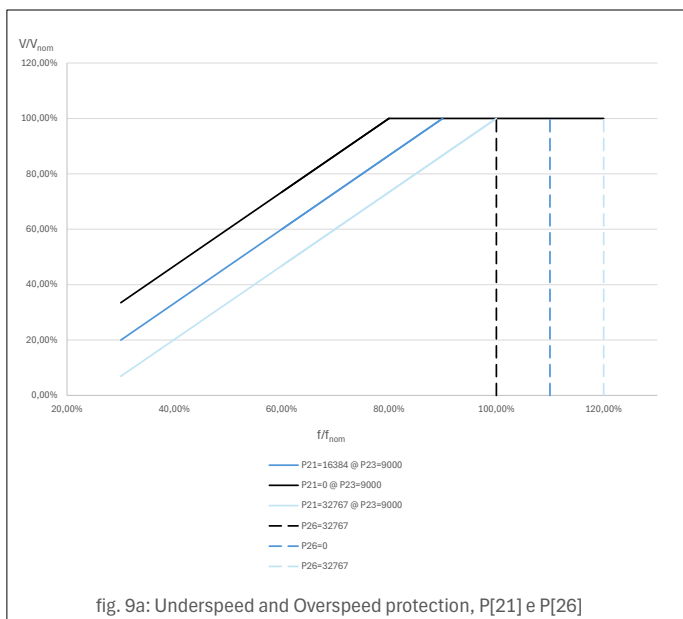

5. Overspeed

Parameter P[26] sets the overspeed alarm intervention threshold; if it is set on 0, the signal cuts in at 55 Hz (if the 50/60 jumper and 50/60 setting in the **Settings/UFLO&LAMS** Menu are absent) or at 66Hz (if the 50/60 jumper is present and enabled or the 50/60 flag in the **Settings/UFLO&LAMS** Menu is activated). Values between 65535 (-1) and 32768 (-32767) lower the threshold proportionately to 50 Hz and 60 Hz, respectively; values between 0 and 32767 raise the threshold proportionately, respectively to 60 Hz and 72 Hz; refer to the broken lines in figure 10a.

6. Other parameters

6.1 Vout / Vaux Ratio

In order to guarantee sufficient feeding voltage at speeds lower than the Hz protection intervention threshold, a limit to the reduction of voltage has been foreseen, as a function of frequency.

The limit concerns regulated voltage (Vout). Should the DER1 be powered through an auxiliary winding, it must be born in mind that the voltage generated by the winding (Vaux) may not have the same Vout value; Vaux is considered proportionate to Vout and the proportional coefficient is determined by **parameter P[14]**.

If the DER1 is powered directly by the regulated phase, parameter 14 should be set on 0; in case it is powered by auxiliary winding or PMG, the voltage (Vaux) must be measured, in no-load conditions and with output voltage regulated on the nominal value (Vout); the value of parameter P[14] can be obtained with the following formula:

$$P[14] = 32767 \cdot \left(\frac{V_{out}}{V_{aux}} - 1 \right)$$

6.2 V/F slope at start up

Parameter P[24] sets the slope proper voltage / frequency at start up. After the underspeed alarm frequency threshold has been exceeded (set by parameter P[21] or by the Hz trimmer), the work ramp is used (parameter P[23]).

The default value is 6000; an increase in the value of P[24] will cause a greater reduction of low frequency voltage; a decrease in the value of P[24] will cause a lower reduction in voltage, up to the limit of P[24]=0, which means that no reduction in voltage will take place.



WARNING: If the voltage is not lowered enough with low frequency and the alternator is operating in these points, overheating could develop that is dangerous for the machine.

6.3 Short circuit time

Parameter P[25] defines the operating time with the alternator short circuited, which is expressed in tenths of a second (from 0.1 seconds to 25.5 seconds); after this period of time the regulator goes to the blocked status; a value of 0 disables the blockage.

6.4 Intervention threshold of low excitation alarm

Starting from rev. 18 of the firmware a warning (alarm A-08) was added in case of low excitation or loss of excitation: if the measured value of excitation voltage does not fall within a preset value range, the anomalous operating condition is signaled (visible on the main panel of the DxR Terminal through the A-08 alarm indicator); no other action is performed by the regulator, except for the switching of APO (if set).

The numeric value identifying in real time the excitation condition is available at location L[56]; the upper detection threshold cannot be modified while the lower threshold can be configured through parameter P[27].

The alarm is activated when the value assumed by location L[56] is higher than the upper threshold or lower than the value assumed by parameter P[27]

For the generators in stand-alone operations, the loss of excitation, on a working regulator, implies also the activation of the low voltage alarm. The underexcitation / loss of excitation alarm is mainly intended for the applications in grid-parallel mode, provided that the regulator stay fully operational (for instance with sufficient residual voltage, direct supply from the phase or from PMG).



CAUTION! :In case of parallel operation of the generators and, most of all, in case of grid-parallel mode, given that the activation of the underexcitation/loss of excitation alarm does not imply any other action, except for the signalling and switching of APO (if enabled), the protection of the system is transferred to at least an appropriate management of the above-mentioned signalling. However, no guarantee is offered for the capacity of the exclusive use of this protection to safeguard the system from all the possible functional anomalies correlated to underexcitation / loss of excitation.

CONTROLLING OF REGULATOR ALARMS

TABLE 12 : ALARMS LIST

N.	Description of event	Action
1	Checksum EEprom	Reset default data - Blockage
2	Over voltage (at rated speed)	APO
3	Under voltage (at rated speed)	APO
4	Short circuit	APO, Maximum current - Blockage
5	Excitation Overcurrent	APO, Reduction of excitation current
6	Underspeed	APO, V/F Ramp
7	Overspeed	APO
8	Underexcitation / loss of excitation	APO

The status of active alarms is stored at location L[38], which can be read with the USB connection. The index of bits that have a value of 1 corresponds to the active alarm. If the regulator is correctly working (no alarm active) the bit 11 will be high.

TABLE 13 : ALARM FLAGS AT LOCATION L[38]

Location L[38] (third "STATUS" box)

B ₁₅	B ₁₄	B ₁₃	B ₁₂	B ₁₁	B ₁₀	B ₉	B ₈	B ₇	B ₆	B ₅	B ₄	B ₃	B ₂	B ₁	B ₀
32768	16384	8192	4096	2048	1024	512	256	128	64	32	16	8	4	2	1
				A12	A11	A10	A9	A8	A7	A6	A5	A4	A3	A2	A1
J50/60	-	Reserved	Reserved	OK	-	-	-	Underexcitation	Over speed	Under speed	Over Excitation	Short	Under voltage	Over voltage	Check sum EEPROM

Example:

Location 38 = 48 = 0000000000110000₂ : it means that Bits B5 and B4 are at 1, therefore alarms A6 and A5 are active.

1. Alarm signals with the indicator lights

During normal operation and a duty cycle of 50% (OK in fig. 11) an indicator light mounted on the board flashes every 2 seconds; it flashes differently in the event of intervention or alarm, as indicated in fig. 11.

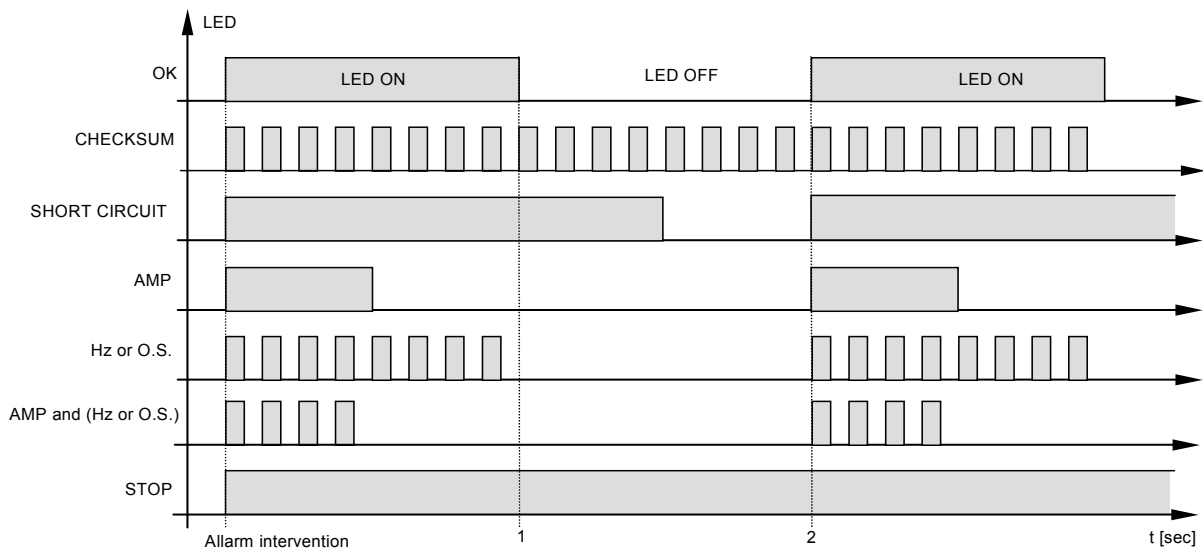
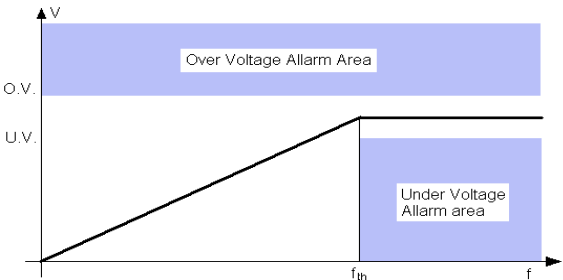

fig.11

2. Description of alarms

TABELLA 14 : DESCRIPTION OF ALARMS

N.	Description of event	Action
1	EEPROM checksum	<p>Verified upon start up (after DSP reset and initialisation of the peripheral). The actions undertaken are: signalling, locating of default settings, saving in EEPROM and regulator blockage.</p> <p>When the machine is switched on again, if the EEPROM is damaged, the alarm will be repeated. Otherwise the regulator will begin to function with default parameters.</p>
2	Over Voltage	<p>The alarm does not determine a change in the LED flash, the APO output is active and the alarm is memorised. This can be caused by abnormal operating conditions (such as overspeed or overloading) or by a breakdown of the regulator. The over voltage alarm is activated if the output voltage is lost. The over voltage is calculated using an opportune template, as a function of the speed and is inhibited during transition, for 2 seconds. In the template for the calculation the threshold is set at 5% above the nominal value.</p> 
3	Under voltage (@ ω_N)	<p>The alarm does not determine a change in the LED flash, is stored and the APO output is active. The under voltage is calculated using an opportune template as a function of the speed (which can be seen in the description of the over voltage alarm); in the template for the calculation the threshold is set at under 5% the nominal value. It intervenes only above the underspeed alarm threshold; it is practically inhibited by this. It is also inhibited in the ent of intervention of the Excitation over voltage and during transients.</p>
4	Short circuit	<p>The alarm is disabled under 20 Hz, is visualised upon activation of the action and memorised. Tolerated short circuit time goes from 0,1 to 25,5 seconds (programmable in 100 ms steps); then the regulator is blocked after saving DD and TT and signals the STOP status. With the time in short circuit set on zero, the blockage is disabled. The STOP condition causes a fall in excitation, with consequent switching off and successive restarting of the regulator and therefore repetition of the cycle.</p>
5	Excitation Overcurrent	<p>The function of this alarm is not only to signal an excessive temperature, but it also has an active function in reducing the cause. In fact, there is an adjustment ring that takes control of voltage after the threshold has been exceeded; the action involves reduction of the excitation current and therefore output voltage. The available parameter is the "current threshold", which determines the balanced value at which the system is stabilised. The alarm is signalled and stored. For calibration see the paragraph on excitation overcurrent.</p>
6	Underspeed	<p>Signalling (immediate) and activation of the V/F ramp. This alarm also appears when the machine is started and stopped. The alarm is not saved among EEPROM data. The alarm intervention threshold depends upon the status of the 50/60 jumper (hardware or software) and on the position of the Hz trimmer or the value of parameter P[21]. Under the threshold the V/F ramp is active.</p>
7	Overspeed	<p>This is visualised in the same manner as the underspeed alarm and does not involve actions on control, but the alarm is stored. The overspeed condition may provoke an over voltage as in the case of capacitive load. The threshold can be set with parameter P[26].</p>
8	underexcitation /loss of excitation	<p>The alarm does not determine a change in the LED flash, enables APO output and is memorized. The alarm condition is recognized by a underexcitation / loss of excitation observer, available for reading at location L[56]: if the value of L[56] is higher than the upper (fixed) threshold or lower than the value of the lower threshold (parameter P[27]), A-08 is activated. The alarm is inhibited during transients.</p>



NOTE: Though the voltage is continuously regulated, the DER1 will switch off if the frequency goes under 20Hz. To reset the system it is necessary to stop completely the alternator.

3. APO Output

The APO output status ((Transistor open collector Active Protection Output - connector CN1 terminals 14 and 15)

depends on:

- whether some alarms are activated or not
- setting of parameter P[17]
- setting of the "APO Invert" flag ⁽²⁾

In normal operating conditions it is closed ^{(2) (3)}. It opens ⁽²⁾ (with a configurable delay from 0 to 15 seconds) when, of all the alarms, one or several separately selectable alarms are active and the "APO Invert" flag ⁽²⁾ is active or, immediately, in case of absence of power supply to the regulator; if the "APO Invert" flag ⁽²⁾ is inactive (or for firmware revisions lower than 18) the APO output is inverted (open in normal operating conditions or with regulator switched off, closed, with a configurable delay, in case of one or several active selected alarms).

The selection of which alarms trigger the activation of A.P.O. depends on the value written at location 17. The transistor is closed ^{(2) (3)} both when no alarm is active and when, even if the alarm is active, the corresponding enabling bit is set to 0.

The value to set at location 17 is made up of 2 parts: one part allows selection of the alarms which activate the contact, the other one allows setting the intervention delay. To calculate the value to set at location 17 use the following procedure:

a) In relation to table 15. Add up the decimal numbers corresponding to the alarms for which you want APO to be activated obtaining number B. (Example: if you want APO to be activated for overvoltage and over-speed, you get $B = 2 + 64 = 66$)

b) Multiply the delay you want (integer values from 0 to 15 seconds) by the fixed value 4096. You get number $A = (0..15) * 4096$. (Example: if you want a 5 seconds delay, you get $A = 5 * 4096 = 20480$)

The sum $A + B$ must be written at location 17 (In the preceding example $20480 + 66 = 20546$)

The configuration is simplified a lot by the use of the DxR terminal software which has the APO settings menu dedicated to this purpose.

TABLE 15 : ALARM SETTINGS THAT ACT ON THE APO

A12	A11	A10	A9	A8	A7	A6	A5	A4	A3	A2
-	-	-	-	Underexcitation	Overspeed	Underspeed	Over Excitation	Short	Under voltage	Over voltage
2048	1024	512	256	128	64	32	16	8	4	2

4. DER1 operation time

If the regulator is working correctly (no alarm) A12 will be active and the bit 11 will be High at location L[38].

When we see one alarm, the A12 is deactivated, bit 11 is reset at location L[38] and operation time is stored.

The total operation time of the regulator is obtained, after the download of the alarms, by adding all the times TT (last column of the file .alr).

For this procedure please refer to the "DownLoad Alarm" function of the Upload/Download Menu of DxR Terminal Software, see Technical guide "Interface communication USB2DxR".

NOTE (1): starting from rev.18 of the Firmware

NOTE (2): Open for firmware revisions lower than 18

APPENDIX : DER1 SET UP ON A TEST BENCH

The operations of functional checkout and parameter setting may turn out to be easier if they are performed on a test bench rather than with the regulator connected to the alternator.

The connection diagrams of the DER1 and the USB2DxR communication interface are shown in figures 12a, 12b or 12c based on the requested function and on the available supply voltage.



Given that some parts of the DER1 which work at high voltage are not isolated, for the safety of the operator, it is necessary for the power source to be isolated from the electrical grid, for instance by a transformer.

The use of these types of connection is reserved to qualified personnel, able to assess the operational risks of high voltage and who have a full knowledge of the content of this manual.

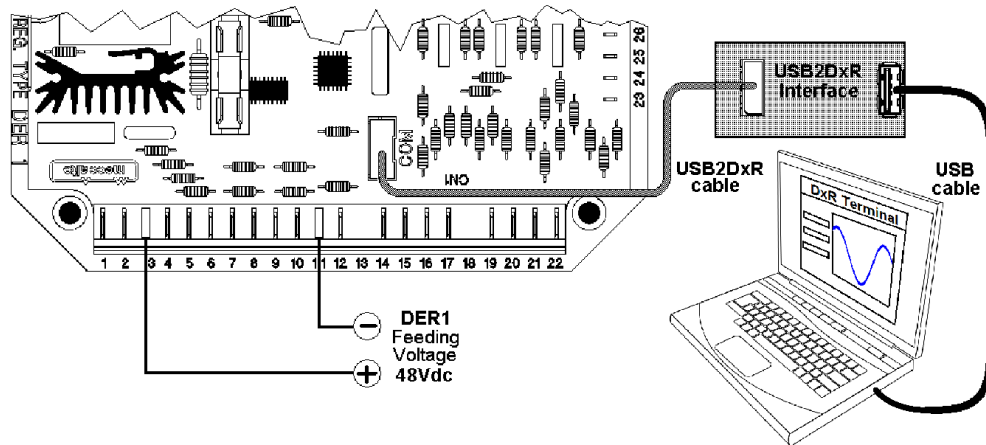

Fig. 12a: DER1 48Vdc power supply (please note that no other connections, other than the power source, are necessary) for the download of the alarms without risking to modify the content of the EEPROM because of the test.

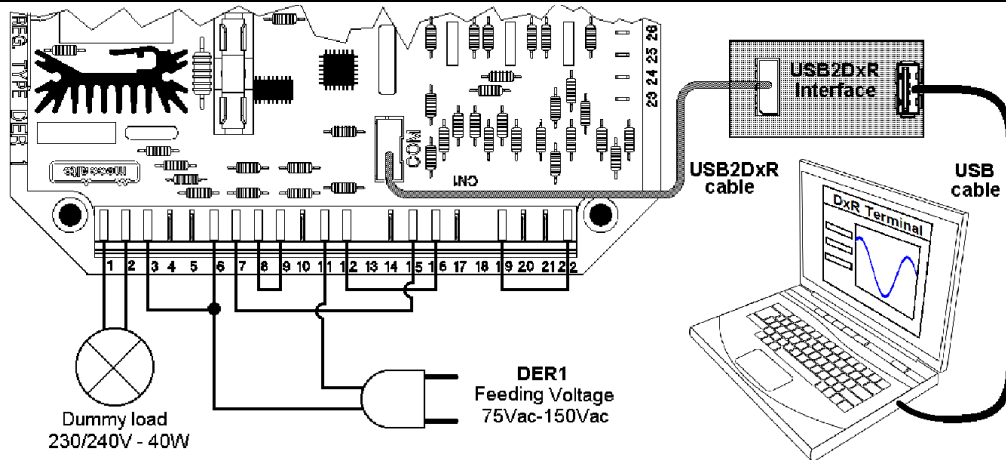

Fig. 12b: DER1 75-145Vac power supply (Please note the sensing on terminal 7 and the jumper between terminals 6 and 3 of the DER1) for test and setup

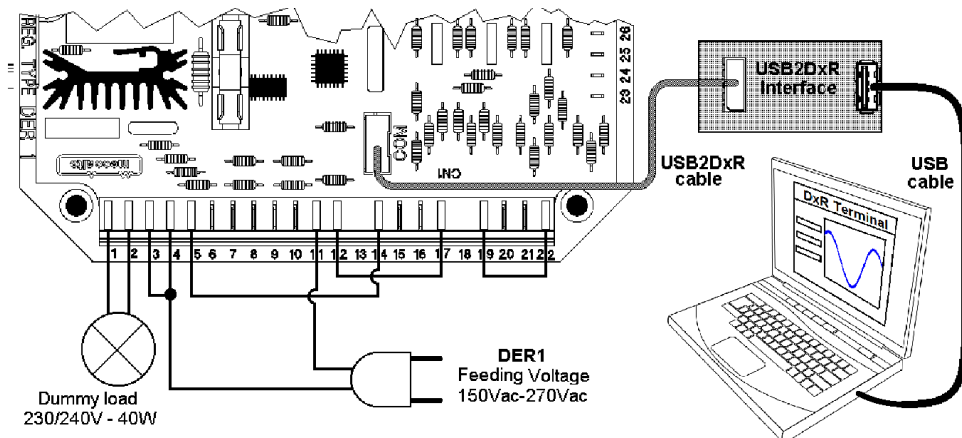

Fig. 12c: DER1 150-270Vac power supply (Please note the sensing on terminal 5 and the jumper between terminals 4 and 3 of the DER1) for test and setup

TECHNICAL REFERENCE GUIDES	
Titolo	Link
Communication interface USB2DxR	http://www.meccalte.com/send_file.php?fileid=Usb2DxR.pdf
Digital Regulators MODBUS communication protocol	http://www.meccalte.com/send_file.php?fileid=MODBUS
Parallel operation	http://www.meccalte.com/send_file.php?fileid=parallel%20manual_PD500.pdf

REVISION HISTORY		
Revision	Date	Description
rev.00	07/11	Initial Release
rev.01	03/12	Edited Note 1) page 5 and added new drawings SCC0158 and SCC0159
rev.02	09/12	Edit Technical specifications - new drawings SCC0202 and SCC0203
rev.03	09/12	Modified drawings SCC0158 and SCC0159
rev.04	05/15	Firmware update rev. 19, added connection scheme filter EMI182/K, cancelled : DI1, software DSR Terminal
rev.05	07/15	Corrections at pages 9, 18 and 19 .
rev.06	09/16	Update of: all SCC with PD500 , PD-I and AVR wires markers, and fig.6,12a,12b,12c
rev.07	09/24	Table 4 and Table 12 corrected, updated graphics

MECC ALTE SPA (HQ)

Via Roma
20 – 36051 Creazzo
Vicenza – ITALY

T: +39 0444 396111
F: +39 0444 396166
E: info@meccalte.it
aftersales@meccalte.it

MECC ALTE PORTABLE

Via A. Volta
137038 Soave
Verona – ITALY

T: +39 0456 173411
F: +39 0456 101880
E: info@meccalte.it

MECC ALTE POWER PRODUCTS

Via Melaro
2 – 36075 Montecchio
Maggiore (VI) – ITALY

T: +39 0444 1831295
F: +39 0444 1831306
E: info@meccalte.it

ZANARDI ALTERNATORI

Via Dei Laghi
48/B – 36077 Altavilla
Vicenza – ITALY

T: +39 0444 370799
F: +39 0444 370330
E: info@zanardialternatori.it

UNITED KINGDOM

Mecc Alte U.K. LTD
6 Lands' End Way
Oakham
Rutland LE15 6RF

T: +44 (0) 1572 771160
F: +44 (0) 1572 771161
E: info@meccalte.co.uk

SPAIN

Mecc Alte España S.A.
C/ Rio Taibilla, 2
Polig. Ind. Los Valeros
03178 Benijofar (Alicante)

T: +34 (0) 96 6702152
F: +34 (0) 96 6700103
E: info@meccalte.es

CHINA

Mecc Alte Alternator Haimen LTD
755 Nanhai East Rd
Jiangsu HEDZ 226100 PRC

T: +86 (0) 513 82325758
F: +86 (0) 513 82325768
E: info@meccalte.cn

INDIA

Mecc Alte India PVT LTD
Plot NO: 1, Sanaswadi
Talegaon
Dhamdhare Road Taluka:
Shirur, District:
Pune - 412208
Maharashtra, India

T: +91 2137 673200
F: +91 2137 673299
E: info@meccalte.in

U.S.A. AND CANADA

Mecc Alte Inc.
1229 Adams Drive
McHenry, IL, 60051

T: +1 815 344 0530
F: +1 815 344 0535
E: info@meccalte.us

GERMANY

Mecc Alte Generatoren GmbH
Bucher Hang 2 D-87448
Waltenhofen

T: +49 (0) 2203 60541-0
F: +49 (0) 2203 60541-49
E: info@meccalte.de

AUSTRALIA

Mecc Alte Alternators PTY LTD
10 Duncan Road, PO Box 1046
Dry Creek, 5094, South
Australia

T: +61 (0) 8 8349 8422
F: +61 (0) 8 8349 8455
E: info@meccalte.com.au

FRANCE

Mecc Alte International S.A.
Z.E. la Gagnerie
16330 St. Amant de Boixe

T: +33 (0) 545 397562
F: +33 (0) 545 398820
E: info@meccalte.fr
aftersales@meccalte.fr

FAR EAST

Mecc Alte (F.E.) PTE LTD
10V Enterprise Road, Enterprise 10
Singapore 627679

T: +65 62 657122
F: +65 62 653991
E: info@meccalte.com.sg



www.meccalte.com

The world's largest independent
producer of alternators 1 – 5,000kVA

