



POWER FROM WITHIN

GC600 REMOTE CONTROLLER



USER MANUAL

Table of Contents

1.	Introduction	5
2.	Views of the device	6
2.1	Installation	7
3.	Configuration	7
4.	Connections	7
4.1	Power supply	7
4.2	Digital outputs	8
4.3	Connecting GC600	8
4.3.1	Connecting GC600 by Ethernet (JY)	8
4.3.1.1	Point-to-point connection	9
4.3.1.2	Connection through hub or switches	9
4.3.1.3	Configuring Remote for connecting to GC600	10
4.3.2	Connecting GC600 by RS485 (JW)	11
4.3.2.1	Connecting to the JW port of GC600	11
4.3.2.2	Connecting to the JA port of GC600	12
4.3.3	Connecting GC600 by RS232 (JA)	14
5.	Security	15
6.	Visible information on Remote	16
6.1	Contrast regulation	16
6.2	Display back-light lamp management	16
6.3	Acoustic feedback for buttons	16
6.4	Brightness of the LED lamps	16
6.5	Colours combinations	17
6.6	Visible information when the communication is OFF-LINE	17
6.6.1	COMMUNICATION INFO	17
6.6.2	ETHERNET INFO	17
6.6.3	CONTROLLER INFO	18
6.6.4	PROGRAMMING	18
6.7	Visible information when the communication is ON-LINE	19
7.	Commands and settings	19
7.1	Selecting the operating mode	20
7.2	START and STOP buttons	20
7.2.1	START and STOP buttons in manual mode	20
7.2.2	START and STOP buttons in automatic mode	20
7.3	MCB and GCB buttons	20
7.4	ACK/ENTER button for alarms management	20
7.4.1	Silencing the acoustic signal	20
7.4.2	Acknowledging the alarms	20
7.4.3	Resetting the alarms	21
7.5	Clearing functions	21
7.6	Changing GC600's parameters	21

1. Introduction

This document describes the "GC600-REMOTE" controller (hereinafter **Remote**). It works as a remote operator panel for another "GC600" controller (hereinafter **GC600**).

This document indicates:

- Wirings and configurations for the **Remote** controller.
- Configurations for the **GC600** controller (to which it is connected).
- The visible information and the available commands of the **Remote** controller.

Remote can only be connected to **GC600** having a firmware version greater than or equal to 01.39. The first version of the **Remote** firmware is in fact 01.39. Also, the **Remote** firmware version cannot be greater than the **GC600** one; it can be smaller, but it is recommended that the two controllers have the same version.

The **Remote** controller firmware has the code: EB025036701xx.

2. Views of the device

Front view



Rear view

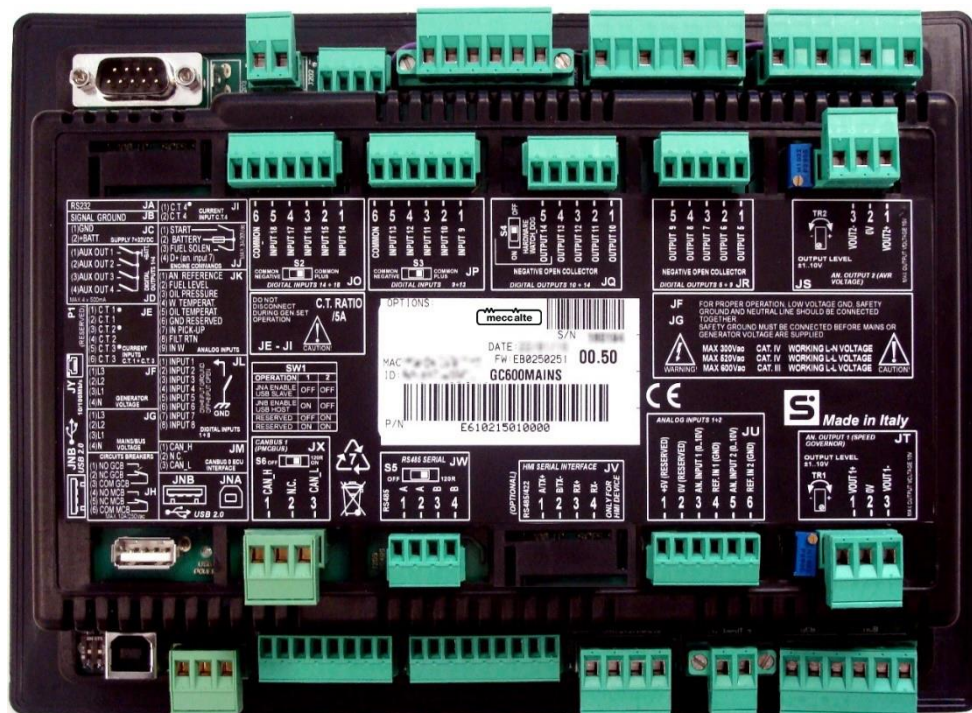

2.1 Installation

The **Remote** controller must be permanently mounted on a panel or on an electrical cabinet. The back of **Remote** must be accessible only using keys or tools, and only by personnel authorized to perform maintenance operations. The device must be mounted so that it cannot be removed without the use of tools.

The cut-out dimensions are 218x159mm. The device is mounted with four hooks with locking screws: once the device is in place, insert the hooks into the side slots and tighten the screws. Be careful not to overtighten the screws to avoid damaging the coupling slots on the casing of the device.

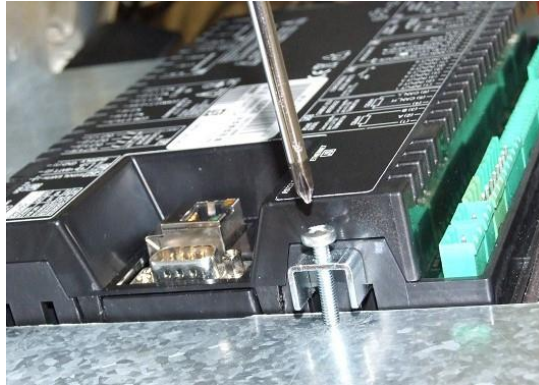

3. Configuration

To configure the parameters, the BoardPrg4 software, produced by Mecc Alte and freely downloadable from the website (www.meccalte.com), is required. Once the software has been installed on a PC, the PC must be connected to **Remote**.

Just connect a USB cable between the PC and the **Remote's** JNA connector: the controller will be visible on the PC as an additional serial port (in case of problems, the Windows driver for the USB port is also freely downloadable from the Mecc Alte website). The two dipswitches located close to the JNA connector (called SW1) must both be in the "OFF" position

It is also possible to use the Ethernet connection to configure the controller: in this case, however, it is necessary to know in advance its current IP address.

The communication protocol used on **Remote** is Modbus: the Modbus address of the controller is "1".

4. Connections

4.1 Power supply

Remote must be powered with a continuous voltage between 8 and 33 Vdc. It is possible to use the engine starter battery voltage (thus power supply common to **GC600**) or a separate power source. Note: the battery voltage displayed on **Remote** is in any case the one of the generating-set, **Remote** does not make any measurements on its own power source.

The JC connector is the power supply connector: connect the DC voltage to the "1 - GND" terminal (negative) and to the "2 - +BATT" terminal (positive).

4.2 Digital outputs

Remote provides two digital outputs (relay 10 Ampere @ 250 Vac). The JH connector provides the dry contacts for the relays:

1. Normally open terminal for output 1.
2. Normally closed terminal for output 1.
3. Common output terminal for output 1.
4. Normally open terminal for output 2.
5. Normally closed terminal for output 2.
6. Common terminal for output 2.

Output 1 (JH-1...3) is activated together with the **Remote** internal buzzer (normally when **GC600** has some alarms). It can be used to control an external lamp or a more powerful external buzzer.

Output 2 (JH-4...6) is activated when **Remote** is connected to **GC600** (ON-LINE).

Since dry contacts are supplied, there are no wiring recommendations.

4.3 Connecting GC600

Remote can be connected to **GC600** via Ethernet or via serial ports. If you choose a serial port connection, you can use both the RS485 port (JW), and the RS232 port (JA) of **Remote**.

The RS232 port is limited in the maximum distance between the two controllers. If needed, it is possible to connect an RS232-RS485 converter (also produced by Mecc Alte). Furthermore, the RS232 port is not isolated: if **Remote** and **GC600** are connected directly by a crossed RS232 cable, the power source of the two controllers must be the same (at least the negative pole must be common).

4.3.1 Connecting GC600 by Ethernet (JY)

GC600 allows up to four simultaneous TCP/IP connections: it is therefore possible to connect four **Remote** controllers to the same **GC600**.

To enable the connection to **GC600** via Ethernet, it is necessary to set the parameter P.0301 of **Remote** to the value "2-Ethernet".

The connection can be made in two ways:

- With a point-to-point connection between the two controllers (only one Ethernet cable connected between the Ethernet ports of **Remote** and **GC600**).
- By connecting the two controllers **Remote** and **GC600** to existing Ethernet networks (using hubs or network switches).

4.3.1.1 Point-to-point connection

Configure **GC600** in this way:

- Parameter P.0500 (IP address): "192.168.1.1".
- Parameter P.0501 (sub-net mask): "255.255.255.0".

Configure **Remote** in this way:

- Parameter P.0301 (connection mode with **GC600**): set to "2-Ethernet".
- Parameter P.0500 (IP address): "192.168.1.2".
- Parameter P.0501 (sub-net mask): "255.255.255.0".

In this way, we have created a sub-network with mask "255.255.255.0"; two devices (with address "192.168.1.1" and "192.168.1.2") are connected to this sub-network. As you can see, the parts of the IP addresses that corresponds to "255" in the "sub-net mask" are identical, while the parts that corresponds to "0" are different.

4.3.1.2 Connection through hub or switches

If **GC600** and **Remote** controllers are connected to existing Ethernet networks, they can be self-configured. In fact, Mecc Alte controllers support the standard DHCP protocol.

Ethernet network with DHCP server.

As soon as the Mecc Alte controllers are connected to the Ethernet network, the DHCP server will tell them which IP address and which sub-net mask to use (and the IP address of the network router).

This function is enabled both on **GC600** and on **Remote** if parameter P.0514 is set to "255.255.255.255" and if parameter P.0513 is set to 67; these are the default values for the two parameters, so the function is enabled by default.

On the displays of the two controllers, you can check the IP address and the sub-net mask assigned by the server:

- On **GC600** select the display page S.05.
- On **Remote** (when the communication is OFF-LINE) press the buttons with the horizontal arrows until you find the "ETHERNET INFO" page.

Note: Mecc Alte controllers also support the standard DNS protocol. This protocol allows you to associate a name (text) to each device connected to the Ethernet network, and then use that name instead of the IP address to request a connection with a remote device. If a DNS server exists in the network (usually it is the DHCP server, or the DHCP server can indicate its IP address), the Mecc Alte controller automatically requires the association of its name to its IP address. The name can be configured with parameter P.0456 both on **GC600** and on **Remote**. By default, the name of each Mecc Alte controller is equivalent to its unique ID, so that there are no duplicates.

Attention: if you do not want to use the DHCP server (and therefore you want to manually configure the Ethernet connection), operate as follows:

- Set parameter P.0514 to "0.0.0.0": this disables the DHCP protocol on **GC600** or on **Remote**.
- Ask the network administrator which IP addresses can be used (they must be excluded from those automatically assigned by the DHCP server).

See below for configuration.

Ethernet network without DHCP server.

If there are no DHCP servers (or if you do not want to use them) first set the parameter P.0514 to "0.0.0.0": this disables the DHCP protocol on **GC600** or on **Remote**.

At this point, ask the network administrator for the sub-net mask values for each Ethernet networks to which Mecc Alte controllers must be connected. Note: **GC600** and **Remote** will normally be connected to the same Ethernet network (and therefore the value for the sub-net mask will be the same for both), but they could also be connected to different networks.

If **GC600** and **Remote** are connected to different Ethernet networks, the administrator must also provide the IP addresses of the "router" of each network.

Finally, the administrator must indicate the correct IP addresses to be assigned to the Mecc Alte controllers.

Use the following parameters (on both **GC600** and **Remote**):

- Parameter P.0500: IP address for the Mecc Alte controller.
- Parameter P.0501: sub-net mask.
- Parameter P.0502: IP address of the network "router".

Note: even without using the DHCP protocol, it is still possible to use the DNS protocol (see previous paragraph). If you want to use this function, however, you need to manually configure the IP address of the DNS server (parameters P.0510 and P.0511 on both **GC600** and **Remote**). Ask the network administrator for the IP address of the DNS server (s).

4.3.1.3 Configuring Remote for connecting to GC600

Once the Ethernet network connection is configured on both **GC600** and **Remote** (see the previous paragraphs), it is necessary to indicate to **Remote** which is the IP address of **GC600**.

Configure **GC600** in this way:

- Parameter P.0503 (Modbus/TCP port): "502".
- Parameter P.0505 (order of Modbus registers): "0-LSWF".

Configure **Remote** in this way:

- Parameter P.0301 (connection mode with **GC600**): set to "2-Ethernet".
- Parameter P.0302 (Modbus address of **GC600**): set to "1".
- Parameter P.0303 (order of **GC600** Modbus registers): set to "0-LSWF" (or to the same value as parameter P.0505 of GC600).
- Parameter P.0331: (IP address of **GC600**): set the IP address assigned to **GC600**, or the "name" of **GC600** (P.0456) if the DNS protocol was used.
- Parameter P.0332: (Modbus/TCP port of **GC600**): set to 502 (or to the value set in P.0503 of GC600).

4.3.2 Connecting GC600 by RS485 (JW)

Remote is equipped with an opto-isolated RS485 serial port, available on the JW connector. This connector has four terminals (internally connected by couples):

- Terminals 1 & 2: connect the A (+) signal of the RS485 line.
- Terminals 3 & 4: connect the B (-) signal of the RS485 line.

The RS485 line must be terminated with a 120 Ohm resistor on both ends. The resistor is already integrated in **Remote** but must be activated by using the S5 switch, located near JW.

Warning: the RS485 line must be dedicated to the communication between **Remote** and **GC600**. No other devices can be connected to the same line (neither master nor slave).

4.3.2.1 Connecting to the JW port of GC600

GC600 is equipped with an opto-isolated RS485 serial port, available on the JW connector. The connection must therefore be:

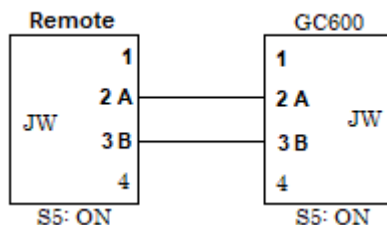

The S5 switch must be in ON position on both controllers. To check for the proper wiring, remove the power supply from both controllers and, with a multimeter, measure the resistance between terminals 2 and 3 of JW connector (on one of the two controllers): it must be around 60 Ohm (58...62).

Configure **GC600** in this way:

- Parameter P.0471 (use of the serial port): "0-Modbus standard".
- Parameter P.0472 (Modbus address): "1".
- Parameter P.0473 (baud rate): "115200".
- Parameter P.0474 (settings): "0-8 bit, no parity, 1 stop".
- Parameter P.0475 (order of Modbus registers): "0-LSWF".

Configure **Remote** in this way:

- Parameter P.0301 (connection mode with **GC600**): set to "0-RS485".
- Parameter P.0302 (Modbus address of **GC600**): set to "1" (or to the same value as parameter P.0472 of **GC600**).
- Parameter P.0303 (order of **GC600** Modbus registers): set to "0-LSWF" (or to the same value as parameter P.0475 of **GC600**).
- Parameter P.0473 (baud rate): set to "115200" (or to the same value as parameter P.0473 of **GC600**).
- Parameter P.0474 (settings): set to "0-8 bit, no parity, 1 stop" (or to the same value as parameter P.0474 of **GC600**).

The indicated baudrate (115200) allows the best performances for **Remote**. However, the maximum selectable baud rate depends on the length of the RS485 line, and on the quality of the cable used. So, select a baud rate suitable for the line length (the following figure can help in the selection).

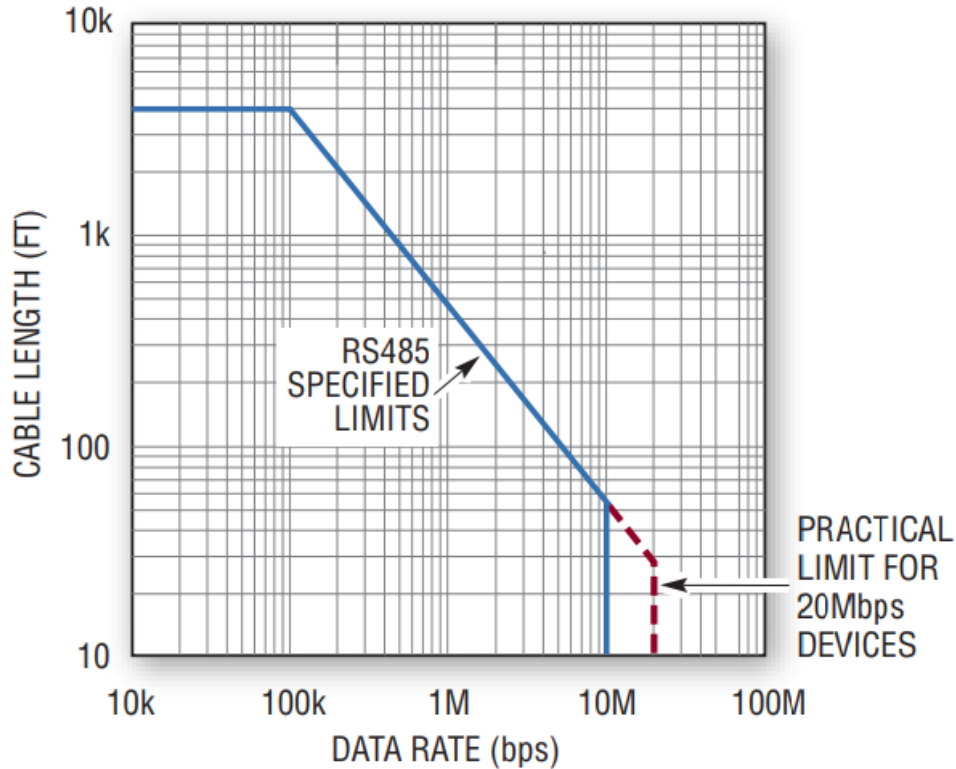

Therefore, theoretically (with ideal cable and state-of-the-art wiring), the maximum length is approximately 1200 meters (4000 feet) for baud rates up to 115200 bps. For greater distances contact Mecc Alte. However, for distances close to 1 km, if you are not sure about the quality of the cabling, reduce the baud rate to 57600 or 38400.

4.3.2.2 Connecting to the JA port of GC600

GC600 is equipped with a non-isolated RS232 serial port, available on the JA connector. For using this port, it will be necessary to use an RS232/RS485 converter. Mecc Alte produces the suitable converter (opto-isolated):

- 12 Vdc version: E610202170002.
- 24 Vdc version: E610202170102.

The connection must therefore be:

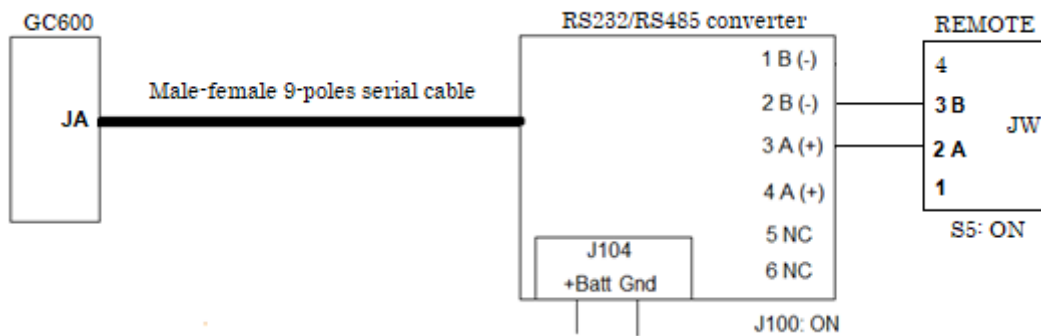

On the RS232 / RS485 converter there is a plug-in jumper called J100. By inserting the jumper, the internal 120 Ohm termination resistor is connected to the RS485 line. The S5 switch of **Remote** is used to insert the termination resistor inside the controller itself. To check for the proper wirings, remove the power supply from **Remote** and from the RS232/RS485 converter and, with a multimeter, measure the resistance between terminals 2 and 3 of **Remote**: it must be around 60 Ohm (58...62).

Configure **GC600** in this way:

- Parameter P.0451 (use of the serial port): "0-RS232/RS485".
- Parameter P.0452 (Modbus address): "1".
- Parameter P.0453 (baud rate): "115200".
- Parameter P.0454 (settings): "0-8 bit, no parity, 1 stop".
- Parameter P.0470 (order of Modbus registers): "0-LSWF".

Configure **Remote** in this way:

- Parameter P.0301 (connection mode with **GC600**): set to "0-RS485".
- Parameter P.0302 (Modbus address of **GC600**): set to "1" (or to the same value as parameter P.0452 of **GC600**).
- Parameter P.0303 (order of **GC600** Modbus registers): set to "0-LSWF" (or to the same value as parameter P.0470 of **GC600**).
- Parameter P.0473 (baud rate): set to "115200" (or to the same value as parameter P.0453 of **GC600**).
- Parameter P.0474 (settings): set to "0-8 bit, no parity, 1 stop" (or to the same value as parameter P.0454 of **GC600**).

See the note in the previous paragraph on selectable baud rates.

4.3.3 Connecting GC600 by RS232 (JA)

Remote is equipped with a non-isolated RS232 serial port, available on the JA connector. You can use this port for a direct connection with the same connector on **GC600**. However, keep in mind that the RS232 port allows very short cable lengths (maximum 12 meters), so in practice, it is a little used solution.

Attention: the connection cable (between **Remote** and **GC600**) directly connects the negative power supply poles of the two controllers, which must therefore be powered by the same power source.

Warning: the RS232 line must be dedicated to the communication between **Remote** and **GC600**. No other devices can be connected to the same line.

The JA connector is a standard 9-pin male connector of the same type used on PCs. The following terminals are used:

- Terminal 2: RX.
- Terminal 3: TX
- Terminal 5: GND

The connection must therefore be:

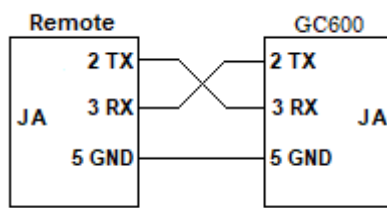

On the market, there are pre-made cables (female/female) that implement the indicated connection: in any case, Mecc Alte can provide the suitable cable.

Configure **GC600** in this way:

- Parameter P.0451 (use of the serial port): "0-RS232/RS485".
- Parameter P.0452 (Modbus address): "1".
- Parameter P.0453 (baud rate): "115200".
- Parameter P.0454 (settings): "0-8 bit, no parity, 1 stop".
- Parameter P.0470 (order of Modbus registers): "0-LSWF".

Configure **Remote** in this way:

- Parameter P.0301 (connection mode with **GC600**): set to "1-RS232".
- Parameter P.0302 (Modbus address of **GC600**): set to "1" (or to the same value as parameter P.0452 of **GC600**).
- Parameter P.0303 (order of **GC600** Modbus registers): set to "0-LSWF" (or to the same value as parameter P.0470 of **GC600**).
- Parameter P.0453 (baud rate): set to "115200" (or to the same value as parameter P.0453 of **GC600**).
- Parameter P.0454 (settings): set to "0-8 bit, no parity, 1 stop" (or to the same value as parameter P.0454 of **GC600**).

5. Security

GC600 provides two different protections for accessing its data through the communication ports:

- Parameter P.0469 allows you to set an alphanumeric password that protects **GC600** from any external writing. By default, this password is empty (therefore not used).
- Parameter P.0004 allows you to set a numeric password that protects **GC600** from executing commands requested from outside. By default, this password is set to "123" (so it is used).

Remote allows both the modification of setpoints on **GC600** and the execution of remote commands (starting/stopping the engine for example). It therefore needs to have full access to **GC600**. For this reason, if the **GC600** has been protected with passwords, the same passwords must be configured into **Remote**:

- P.0304 (password for the commands on the communication ports): set the value configured in parameter P.0004 of **GC600**.
- P.0305 (password for accessing the communication ports): set the value configured in parameter P.0469 of **GC600**.

If the passwords of **GC600** are not configured correctly into **Remote**, commands cannot be executed, and some information will not be displayed correctly.

6. Visible information on Remote

6.1 Contrast regulation

You can change the contrast level of the **Remote** display using the ESC/SHIFT + ← → combination.

The selected level is automatically saved in the non-volatile memory and will therefore be maintained even if the power supply of **Remote** is disconnected.

6.2 Display back-light lamp management

The backlight lamp is automatically turned on by **Remote** every time a button is pressed. It remains activated for a time configured with parameter P.0492 (by default "999" seconds): if no buttons are pressed for this time, the lamp is switched off. Parameter P.0492 can be set to "0": in this case the lamp will always remain on.

When the communication is ON-LINE, it is possible to configure **Remote** to keep the lamp activated when the engine is running (parameter P.0493).

6.3 Acoustic feedback for buttons

By default, **Remote** briefly activates the internal buzzer whenever a button is pressed. It is used to give better feedback to the operator. This function can be disabled using parameter P.0495. It is a bit parameter: activating bit seven the function is disabled.

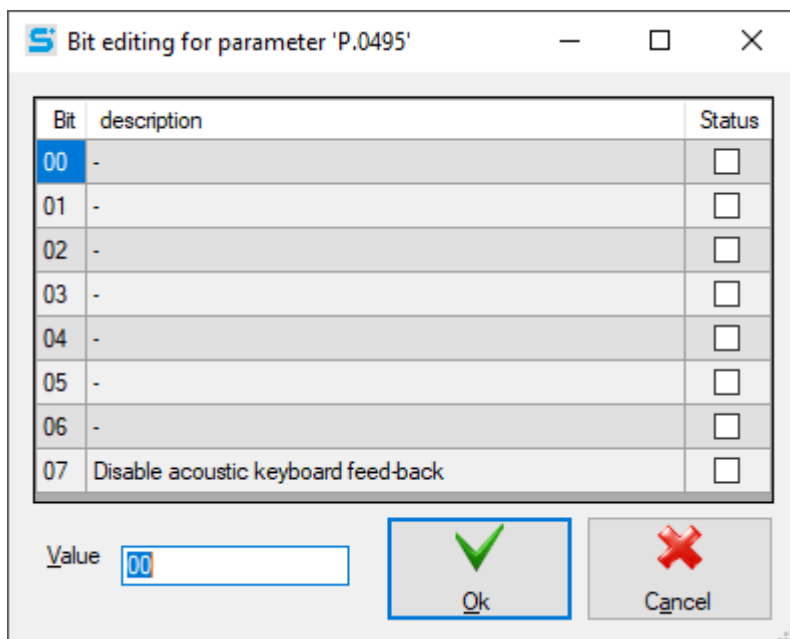

6.4 Brightness of the LED lamps

Parameter P.0496 of **Remote** allows you to change the brightness of the LED lamps. The parameter accepts values between 1 and 10, where 1 corresponds to the minimum brightness. The default value is five.

6.5 Colours combinations

Like **GC600, Remote** also allows you to select the colour scheme to be used on the display. Parameter P.0499 allows you to choose between:

- 0: BLU background.
- 1: NERO background.
- 2: BIANCO background.

These are the same values that can be selected on **GC600**: it is however possible to configure **GC600** and **Remote** with two different colour combinations.

Note: **Remote** uses the selected colour combination only when it is ON-LINE: when it is OFF-LINE, it uses red texts on a black background.

6.6 Visible information when the communication is OFF-LINE

The OFF-LINE condition (**Remote** cannot communicate with **GC600**) is signalled by the simultaneous flashing of all the display lamps. In addition, the relay output on terminals 4...6 of the JH connector is de-energized (then the "normally closed" contact closes).

In this phase, **Remote** shows its status by various display pages (red texts on black background) and allows the modification of its configuration parameters. You can use either the vertical or horizontal arrows buttons to move across the various available pages.

Below a description of the pages.

6.6.1 COMMUNICATION INFO

The information displayed depends on parameter P.0301, and therefore on which communication port of **Remote** you want to use for connecting with **GC600**.

In any case, it shows the Modbus address of **GC600** (parameter P.0302 of **Remote**).

- RS485: it shows the configuration of the RS485 (JW) port of **Remote** (for example "RS485: 115200, 8, N, 1"). Parameters P.0473 and P.0474 of **Remote**.
- RS232: it shows the configuration of the RS232 (JA) port of **Remote** (for example "RS232: 115200, 8, N, 1"). Parameters P.0453 and P.0454 of **Remote**.
- Ethernet: it shows the IP address and TCP port of **GC600** (parameters P.0331 and P.0332 of **Remote**). If a name has been configured in P.0331 instead of the IP address (DNS protocol), the page shows both the name and the corresponding IP address received from the DNS server.

6.6.2 ETHERNET INFO.

It shows the Ethernet network configuration for **Remote**:

- The MAC address of the physical Ethernet interface.
- The name assigned to **Remote** (DNS).
- The IP address assigned to **Remote**.
- The sub-net mask of the Ethernet sub-network.
- The IP address of the router of the Ethernet sub-network.

- The IP address of the DNS server.

The last four values can be those configured on **Remote** (P.0500, P.0501, P.0502, P.0510) or those received from the DHCP server (see paragraph 4.3.1.2).

The page also indicates whether the network cable is plugged into the JY connector or not (or better if the JY is connected via an Ethernet cable to some other device).

6.6.3 CONTROLLER INFO

It shows the firmware version of **Remote** and its unique ID.

It also allows you to select the language: all the languages available on the **GC600** are present in **Remote**. The selected language will also be used in ON-LINE mode, whatever the language selected on the **GC600**.

6.6.4 PROGRAMMING

It allows you to edit all specific parameters of **Remote**. It is identical to the **GC600** programming page, so please refer to the **GC600** manuals for an in-depth description.

Some **Remote** parameters are identified by the same numerical code as the equivalent ones of **GC600**: be careful not to confuse them.

Remote parameters can be protected with passwords. There are two password levels:

- Installer (the person who takes care of the commissioning of **Remote**).
- User (the person using **Remote**).

Each parameter of **Remote** is protected by one of the two previous levels. The document EAAM0767xxXA (where "xx" is the version) indicates the level of protection required for each parameter.

A password can be associated to each level, respectively with parameters P.0002 and P.0003. By default, both the previous parameters are set to zero (password disabled), so all the parameters of **Remote** can be freely modified by anyone. Note: parameters P.0002 and P.0003 are also present in **GC600**, but each one protects the parameters of its own controller.

It is possible to configure a password for both levels, for one of them, or for none. If P.0002 and/or P.0003 are configured, before being able to modify a parameter of **Remote**, the correct password must be set (LOGIN) into parameter P.0000. However, if you try to change a parameter that is currently protected by a password, **Remote** immediately asks you to type the correct password: if the operation is successful, you can then change the required parameter.

Programming is organized in menus. From the entry page, press the ACK/ENTER button to access the main menu. Use the vertical arrows buttons to select a submenu and press the ACK/ENTER button to enter it. Press the ESC/SHIFT button to exit a submenu and return to the upper one. Press ESC/SHIFT from the main menu to return to the entry page, from where it is possible to move to the "XXX INFO" pages described in the previous paragraphs.

Once you have reached the desired submenu, use the vertical arrows buttons to select the required parameter. Only one parameter is shown at a time:

- The numeric identifier of the parameter is shown in the upper part of the page, followed by the description in the selected language (for example "000-Access code").
- At the bottom right, the current parameter value is displayed between two square brackets. If it is enclosed between the symbols "<" and ">", it means that it is protected by a password and that at the moment the operator has not yet typed that password.

Press the ACK/ENTER button to change the parameter: if it is password protected, the controller will ask the operator to type the password. The square brackets surrounding the value now flash to indicate that the change is in progress.

Use the vertical arrow buttons to change the parameter. Confirm the change with the ACK/ENTER button or cancel it with the ESC/SHIFT button.

6.7 Visible information when the communication is ON-LINE

The ON-LINE condition (**Remote** can communicate with **GC600**) is signalled with the activation of the relay output on terminals 4...6 of the JH connector (then the "normally open" contact closes).

When communication is ON-LINE, **Remote** shows exactly (without exceptions) the same display pages as **GC600**. The controller' lamps are also faithfully reproduced. The page displayed by **Remote** is independent from that displayed by **GC600**: the two controllers can display different pages.

In the first seconds after passing from the OFF-LINE to the ON-LINE condition, **Remote** must read the entire configuration from **GC600**. In this phase, the display shows progress bars, allowing the operator to understand what is happening.

Note: it is possible to modify the specific parameters of **Remote** even while the communication is ON-LINE. Press the ESC/SHIFT button for 5 seconds (alone): **Remote** will show its programming menu. To make it clear to the operator that parameters of **Remote** are being changed and not those of the **GC600**, all the display lamps flash simultaneously. Press the ESC/SHIFT button at the end of programming to display the **GC600** pages again.

7. Commands and settings

Note: many of the commands described below are not executed by **GC600** if the parameter P.0304 of **Remote** and P.0004 of **GC600** are set to different values.

Note: on **GC600** it is possible to configure a digital input with the function "2706 - Enable commands from serial ports". If such an input exists, **Remote** commands are executed only if the input is active (connected to GND).

Any command available from the **GC600** operator panel is also available from **Remote**. There are some exceptions which will be highlighted below.

However, it is possible to selectively disable the commands on **Remote**, using parameter P.0449. It is a bit parameter: activating a bit, a group of commands is disabled.

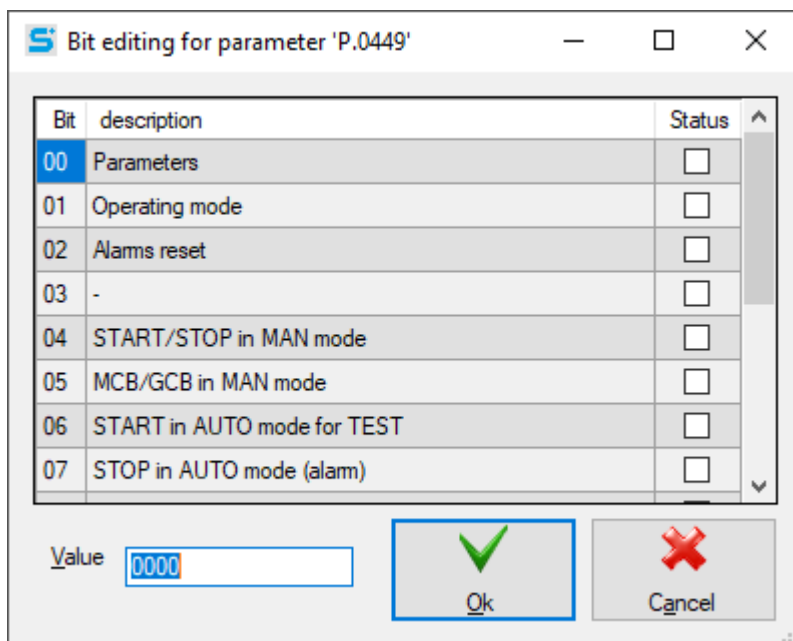

By default, all bits are zero, and therefore all commands are enabled.

A brief description of the available commands follows.

7.1 Selecting the operating mode

These commands are disabled if bit one of P.0449 is set.

Using the two MODE-UP and MODE-DOWN buttons (at the bottom right of **Remote**), it is possible to change the operating mode of **GC600** between OFF/RESET, MAN and AUTO. The buttons must be pressed for at least half a second.

7.2 START and STOP buttons

7.2.1 START and STOP buttons in manual mode

These commands are disabled if bit four of P.0449 is set.

START and STOP buttons on **Remote** can be used when **GC600** is in manual mode to start and stop the engine.

The START button behaves differently from that of the **GC600**. Whatever, in fact, the setting of bit one of parameter P.0495 of **GC600** ("enable automatic start in manual"), by pressing START on **Remote**, **GC600** will perform an automatic start cycle of the duration configured with P.0210.

7.2.2 START and STOP buttons in automatic mode

If **GC600** is in AUTO mode, the START button on **Remote** can be used to switch to TEST mode and vice versa. This command is disabled by bit six of **Remote** parameter P.0449.

If **GC600** is in AUTO mode, the STOP button on **Remote** can be used to perform an emergency engine stop. This command is disabled by bit seven of **Remote** parameter P.0449. Note: this function can also be disabled locally on **GC600** with bit zero of parameter P.0495.

7.3 MCB and GCB buttons

These commands are disabled if bit five of P.0449 is set.

MCB and GCB buttons on **Remote** can be used when **GC600** is in manual mode to open and close the respective circuit breakers. They follow the same rules as the buttons of **GC600**:

- To open the MCB with the engine stopped, press the MCB button for 5 seconds.
- GCB cannot be closed if the generator voltage and frequency are out of tolerance.

7.4 ACK/ENTER button for alarms management

These commands are disabled if bit two of P.0449 is set.

7.4.1 Silencing the acoustic signal

If you press the ACK/SHIFT button on **Remote** while the internal buzzer is activated, **Remote** turns off its buzzer and sends to **GC600** the command to silence its own as well.

7.4.2 Acknowledging the alarms

If the ACK/SHIFT button on **Remote** is pressed while the internal buzzer is switched off and there are anomalies not yet recognized (flashing on the display), **Remote** sends the command to recognize the anomalies to **GC600**. The faults stop flashing on the display: the warning for which the triggering cause is no longer present are automatically reset.

7.4.3 Resetting the alarms

If the ACK/SHIFT button on **Remote** is held down for 5 seconds, **Remote** sends the command to reset the alarms to **GC600**.

Note: to reset the alarms from **Remote**, it is also possible to force the **GC600** operating mode to OFF/RESET (see 7.1).

7.5 Clearing functions

On **GC600**, the combination of the ACK/ENTER + ESC/SHIFT buttons for 5 seconds causes a reset operation which depends on what is shown on the display. The same combination of buttons can be used by **Remote**, with some restrictions:

- By pressing the two buttons from the programming pages on **GC600**, the default values for all the parameters are loaded. This operation is too dangerous by **Remote**, so it has been disabled.
- By pressing the two buttons from the "S" page dedicated to SMARTCLOUD, **GC600** forces the transmission of a data packet. On **Remote**, this command does not work.
- By pressing the two buttons on the "S" page dedicated to CAN communication, the error counters are reset, and the BUS-OFF state is exited.
- By pressing the two buttons from the "E" pages, the selected engine hours counter is reset.
- By pressing the two buttons from the "M" pages, the selected energy counter is reset.
- By pressing the two buttons from "H" pages, the selected historical archive is reset.

7.6 Changing GC600's parameters

These commands are disabled if bit zero of P.0449 is set.

All the parameters of **GC600** can be modified from **Remote**, with the same rules with which they can be modified from **GC600**.

MECC ALTE SPA (HQ)

Via Roma
20 – 36051 Creazzo
Vicenza – ITALY

T: +39 0444 396111
F: +39 0444 396166
E: info@meccalte.it
aftersales@meccalte.it

MECC ALTE PORTABLE

Via A. Volta
1 37038 Soave
Verona – ITALY

T: +39 0456 173411
F: +39 0456 101880
E: info@meccalte.it
aftersales@meccalte.it

MECC ALTE POWER PRODUCTS

Via Melaro
2 – 36075 Montecchio
Maggiore (VI) – ITALY

T: +39 0444 1831295
F: +39 0444 1831306
E: info@meccalte.it
aftersales@meccalte.it

ZANARDI ALTERNATORI

Via Dei Laghi
48/B – 36077 Altavilla
Vicenza – ITALY

T: +39 0444 370799
F: +39 0444 370330
E: info@zanardialternatori.it

UNITED KINGDOM

Mecc Alte U.K. LTD
6 Lands' End Way
Oakham
Rutland LE15 6RF

T: +44 (0) 1572 771160
F: +44 (0) 1572 771161
E: info@meccalte.co.uk
aftersales@meccalte.co.uk

SPAIN

Mecc Alte España S.A.
C/ Rio Taibilla, 2
Polig. Ind. Los Valeros
03178 Benijofar (Alicante)

T: +34 (0) 96 6702152
F: +34 (0) 96 6700103
E: info@meccalte.es
aftersales@meccalte.es

CHINA

Mecc Alte Alternator
(Nantong) Ltd
755 Nanhai East Rd
Jiangsu Nantong HEDZ 226100
People's Republic of China

T: +86 (0) 513 82325758
F: +86 (0) 513 82325768
E: info@meccalte.cn
aftersales@meccalte.cn

INDIA

Mecc Alte India PVT LTD
Plot NO: 1, Talegaon
Dhamdhare S.O.
Taluka: Shirur,
District: Pune - 412208
Maharashtra, India

T: +91 2137 673200
F: +91 2137 673299
E: info@meccalte.in
aftersales@meccalte.in

U.S.A. AND CANADA

Mecc Alte Inc.
1229 Adams Drive
McHenry, IL, 60051

T: +1 815 344 0530
F: +1 815 344 0535
E: info@meccalte.us
aftersales@meccalte.us

GERMANY

Mecc Alte Generatoren GmbH
Bucher Hang 2
D-87448 Waltenhofen

T: +49 (0) 831 540755 0
E: info@meccalte.de
aftersales@meccalte.de

AUSTRALIA

Mecc Alte Alternators PTY LTD
10 Duncan Road, PO Box 1046
Dry Creek, 5094, South
Australia

T: +61 (0) 8 8349 8422
F: +61 (0) 8 8349 8455
E: info@meccalte.com.au
aftersales@meccalte.com.au

FRANCE

Mecc Alte International S.A.
Z.E. la Gagnerie
16330 St. Amant de Boixe

T: +33 (0) 545 397562
F: +33 (0) 545 398820
E: info@meccalte.fr
aftersales@meccalte.fr

FAR EAST

Mecc Alte (F.E.) PTE LTD
10V Enterprise Road, Enterprise 10
Singapore 627679

T: +65 62 657122
F: +65 62 653991
E: info@meccalte.com.sg
aftersales@meccalte.com.sg



www.meccalte.com

The world's largest independent
producer of alternators 1 – 5,000kVA



Filename: EAAM076900EN.docx
Rev. 00 | Date: 01/06/2022
ID Document: EAAM0769
Product: GC600-Remote